

An Algorithmic Toolbox for Network Calculus

Anne Bouillard * Éric Thierry †

Abstract

Network Calculus offers powerful tools to analyze the performances in communication networks, in particular to obtain deterministic bounds. This theory is based on a strong mathematical ground, notably by the use of $(\min,+)$ algebra. However, the algorithmic aspects of this theory have not been much addressed yet. This paper is an attempt to provide some efficient algorithms implementing Network Calculus operations for some classical functions.

Some functions which are often used are the piecewise affine functions which ultimately have a constant growth. As a first step towards algorithmic design, we present a class containing these functions and closed under the main Network Calculus operations (\min , \max , $+$, $-$, convolution, subadditive closure, deconvolution): the piecewise affine functions which are ultimately pseudo-periodic. They can be finitely described which enables us to propose some algorithms for each of the Network Calculus operations. We finally analyze their computational complexity.

Keywords: Network Calculus, functional $(\min,+)$ algebra, algorithmics, computational complexity.

1 Introduction

Network Calculus is a theory of deterministic queuing systems encountered in communications networks. It is based on $(\min,+)$ algebra and it can be seen as a $(\min,+)$ filtering theory by analogy with the $(+,\times)$ filtering theory used in traditional system theory. More than just a formalism, it enables to analyze complex systems and to prove deterministic bounds on delays, backlogs and other Quality-of-Service (QoS) parameters. The information about the system features are stored

*IRISA/ENS Cachan (Bretagne), Campus de Ker Lann, 35170 BRUZ, France. Email: Anne.Bouillard@bretagne.ens-cachan.fr.

†LIP (ENS Lyon, CNRS UMR 5668, INRIA, UCBL), 46, allée d'Italie, 69364 LYON CEDEX 07, Email : Eric.Thierry@ens-lyon.fr

in functions, such as arrival curves for data flows or service curves for service guarantees of the network nodes. These functions can be combined together thanks to special Network Calculus operations, in order to analyze the system and compute bounds.

At the present time, the theory has encompassed and yielded many results which are mainly recorded in two reference books: Chang's book [Chang, 2000] and Le Boudec and Thiran's book [Le Boudec and Thiran, 2001].

However, a central question has not been much addressed for now: which algorithms efficiently implement the Network Calculus operations?

Several results presented in the reference books [Chang, 2000, Le Boudec and Thiran, 2001] have an algorithmic flavor. They present some formularies with algebraic rules of transformation when combining the different Network Calculus operations, they give some examples of functions for which the output of some operations can be easily described (such as convex piecewise affine functions, concave functions or star-shaped functions). Moreover, they illustrate their results by examples and sometimes provide closed formulas for very special cases. For instance, an exact value of the deconvolution of some *Variable Bit Rate* (VBR) arrival curves by rate-latency services is given in [Le Boudec and Thiran, 2001]. The implementation of Network Calculus is not treated.

Some authors have explored the Legendre-Fenchel Transform ($f(t) \mapsto \mathcal{C}(\lambda) = \sup_t(\lambda t - f(t))$) in order to simplify calculations. This transform, also called convex conjugate function or \mathcal{C} -transform [Chang, 1999], is a powerful tool of convex analysis [Rockfellar, 1996]. It is an analogue in the $(\min, +)$ setting of the Fourier Transform or the Laplace Transform in $(+, \times)$ conventional signal and system theory [Oppenheim et al., 1997]. Its use seemed promising (e.g. convolution becomes addition for the transformed functions) and proves to be useful for convex and concave functions [Fidler and Recker, 2006]. However, one important issue is that this transform is not injective for non-convex functions. Attempts to use such a transform to achieve computations have not succeeded yet for general cases [Pandit et al., 2004a, Pandit, 2006].

Several attempts also aimed at providing some closed formulas for special cases. For instance, the authors of [Pandit et al., 2004a, Pandit, 2006] managed to give a closed formula for the convolution of two piecewise affine functions with three pieces each. Their formula already contains a lot of cases and they could not avoid a very heavy case by case proof. There is little hope to generalize such a proof since the number of cases seems to explode quickly. For an interesting discussion about all these attempts, the reader is referred to Pandit et al. works [Pandit et al., 2004a, Pandit et al., 2004b, Pandit et al., 2006, Pandit, 2006].

From a practical point of view, some implementations of Network Calculus operations have been proposed, but as far as we know they rather use brute force algorithms and work for very restricted sets of functions, for instance functions defined over a bounded set (and not $[0, +\infty[$). One can mention the MATHEMATICA implementation of Thiele [Thiele]: it deals with piecewise affine functions defined over \mathbb{R}_+ which are not necessarily increasing. The code is short, but a careful look shows that the set of input functions for which it produces an exact output is not clearly specified. Moreover there is no algorithm computing exactly the subadditive closure and no complexity analysis is given.

However, a software is being developed using this theory for the study of feed-forward networks. In [Schmitt and Zdarsky, 2006, Schmitt et al., 2006], the tool DISCO Network Calculator is described and algorithms are given for convex and concave functions.

Among the works related to these questions, one must mention the studies of $(\min, +)$ or $(\max, +)$ linear systems in Baccelli et al's book [Baccelli et al., 1992] and in Gaubert's thesis [Gaubert, 1992]. In particular, they introduce formal power series in two variables γ and δ , which can be used to represent some functions from \mathbb{N} into \mathbb{R} or from \mathbb{R}_+ into \mathbb{R} , and to perform calculations close to the Network Calculus operations. In [Pandit et al., 2004b, Pandit et al., 2006, Pandit, 2006], their use is shortly discussed as the Γ -transform, but dismissed by those authors for exact calculations due to discretizations which lead to approximative representations. However, this tool provides exact results for a large class of functions. Moreover, the manipulation of these series has been implemented by Gaubert [Gaubert] and Hardouin's team [Cottenceau et al] for SCILAB. Our results are actually related to the ones presented in [Baccelli et al., 1992, Gaubert, 1992], in particular our stability theorems. We will discuss it in the paper.

Our approach has two steps:

1. finding a good class of functions for the Network Calculus operations;
2. designing algorithms which implement these operations for this class.

Section 2 presents the main Network Calculus operations, namely $+$, $-$, \min , \max , $*$, \oslash and the sub-additive closure.

The first step consisting of finding a good class of functions is developed in Section 3.

Transferring the mathematical theory into the algorithmic field involves making choices to restrict a little the general theory so that we can apply effective methods: functions with a finite representation and that are stable for the Network calculus operations constitute a good class of

functions.

Our first concern was to include some usual functions of Network Calculus like the piecewise affine functions which ultimately have a constant growth. They are used for instance to describe arrival curves which constrained input flows (such as $\gamma_{r,b}(t) = rt + b$ arrival curves) and service curves which guarantee the services provided by network elements (such as $\beta_{R,T}(t) = R(t - T)_+$ service curves).

We were also confronted to the choice of the definition sets of our functions. Functions are usually defined from a set X into a set Y , where these two sets are chosen among \mathbb{N} , \mathbb{Z} , \mathbb{Q} or \mathbb{R} . In this paper, we will both focus on functions from \mathbb{N} into \mathbb{R} (*discrete model*) and functions from \mathbb{R}_+ into \mathbb{R} (*fluid model*). We will carefully discuss the associated issues when switching between all these sets.

The main result of this section is the characterization of a set of functions closed under all the operations and containing the usual functions. The good news is that the functions of this closed set are ultimately pseudo-periodic and thus can be finitely described which enables algorithmic design.

The second part of our work, developed in Section 4, consists of finding efficient algorithms that compute the Network Calculus operations for this closed set of functions. The algorithms are derived from the stability results of the first part and their proofs. In particular, they use the decomposition of functions into elementary functions, for which the calculations are simple. We point out how computational geometry may help.

In Network Calculus, the manipulated functions are usually supposed to be positive and non-decreasing, however we will not restrict ourselves to these conditions since we wish to design algorithms as general as possible, for instance to allow some intermediate calculations that may use some non-increasing or negative functions, even if they do not have a direct “physical” interpretation.

Section 5 concludes the paper with a discussion and some perspectives.

2 Definitions and notation

2.1 The main operations

In the usual setting, Network Calculus functions take their values in the dioid $(\min, +)$, denoted $(\mathbb{R}_{\min}, \min, +)$, which is defined on $\mathbb{R}_{\min} = \mathbb{R} \cup \{+\infty\}$ and where the two basic operations are

the usual minimum \min and addition $+$. These functions are also commonly supposed to be non-decreasing.

However, for the sake of generality, we will allow functions which are not necessarily increasing and with values within $\overline{\mathbb{R}} = \mathbb{R} \cup \{-\infty, +\infty\}$.

Let $X = \mathbb{N}$ or \mathbb{R}_+ and f, g be two functions from X into $\overline{\mathbb{R}}$, the Network Calculus makes use of the following operations:

1. **Minimum:** $\forall t \in X, \min(f, g)(t) = \min(f(t), g(t))$. We will also use the infix notation \oplus : $f \oplus g = \min(f, g)$.
2. **Addition:** $\forall t \in X, (f + g)(t) = f(t) + g(t)$.
3. **Convolution:** $\forall t \in X, (f * g)(t) = \inf_{0 \leq s \leq t} (f(s) + g(t - s))$.
4. **Deconvolution:** $\forall t \in X, (f \oslash g)(t) = \sup_{u \geq 0} (f(t + u) - g(u))$.
5. **Subadditive closure:** $\forall t \in X, f^*(t) = \inf_{n \geq 0} f^{(n)}(t)$, where $f^{(n)}(t) = \underbrace{(f * \dots * f)}_{n \text{ times}}(t)$ for $n \geq 1$, and $f^{(0)}(t) = 0$ if $t = 0$ and $+\infty$ if $t > 0$.

Note that we can similarly define the **maximum** (\max) and the **subtraction** ($-$) of two functions. Remark that if $f(0) < 0$, then $\forall t \in X, f^*(t) = -\infty$.

Depending on whether $X = \mathbb{N}$ or $X = \mathbb{R}_+$, we will denote by \mathcal{D} the set of all functions from \mathbb{N} into $\overline{\mathbb{R}}$ (*discrete model*) and by \mathcal{F} the set of all functions from \mathbb{R}_+ into $\overline{\mathbb{R}}$ (*fluid model*). Let $f \in \mathcal{D}$ or \mathcal{F} , the subset $Supp(f) = \{t \in X \mid |f(t)| < +\infty\}$ is called the *support* of f .

The first comment on these operations is that the output function is always well-defined, unless some infinite values interfere. We actually consider that $(+\infty) + (-\infty)$, $(+\infty) - (+\infty)$ and $(-\infty) - (-\infty)$ are undefined values and any operation on two given functions whose definition involves such cases will lead to an undefined output. Checking whether a combination of functions and operations is undefined for some arguments is easy (from both mathematical and algorithmic points of view).

Let $f, g \in \mathcal{D}$ or \mathcal{F} , $\min(f, g)$ and $\max(f, g)$ are always defined, $f + g$ is undefined if $\exists t, f(t) = +\infty$ and $g(t) = -\infty$ (or the contrary), $f - g$ is undefined if $\exists t, f(t) = g(t) = +\infty$ (or $-\infty$), $f * g$ is undefined if $\exists t_1, t_2, f(t_1) = +\infty$ and $g(t_2) = -\infty$ (or the contrary), $f \oslash g$ is undefined if $\exists t_1 \leq t_2, f(t_2) = g(t_1) = +\infty$ (or $-\infty$), f^* is undefined if $\exists t_1, t_2, f(t_1) = +\infty$ and $f(t_2) = -\infty$.

Thus in the paper, each time we write formulas, we will assume that all conditions are fulfilled so that they are well-defined for *all* arguments.

Note that most of the results presented in this paper remain true when forbidding the infinite values. Moreover, allowing them has the drawback to lengthen the proofs because it introduces

each time a few special cases to deal with. However, these new cases can be solved quickly, and allowing infinite values proves to be interesting for modeling purposes as well as for algebraic manipulations and decompositions. Consequently, for the sake of generality and commodity, we allow them.

When $f \in \mathcal{D}$ or \mathcal{F} , and $f(0) \geq 0$, the subadditive closure can be equivalently defined as $f^*(0) = 0$ and for $t > 0$,

$$f^*(t) = \inf_{k \in \mathbb{N}, t_1, \dots, t_k > 0, t_1 + \dots + t_k = t} (f(t_1) + \dots + f(t_k)). \quad (1)$$

When $f \in \mathcal{D}$ and $f(0) \geq 0$, the subadditive closure also has an equivalent recursive definition: $f^*(0) = 0$ and for $t > 0$, $f^*(t) = \min[f(t), \min_{0 < s < t} (f^*(s) + f^*(t - s))]$ (see [Chang, 2000]).

Concerning the *deconvolution*, we should say *truncated deconvolution* since the usual definition gives a function $f \oslash g$ which is defined on \mathbb{Z} in the discrete model or on \mathbb{R} in the fluid model, rather than \mathbb{N} or \mathbb{R}_+ . However, in the context of Network Calculus, where we will combine all these operations starting from functions in \mathcal{D} or \mathcal{F} , we can restrict ourselves to the definition on \mathbb{N} or \mathbb{R}_+ without loss of generality, as it can be seen from the definitions of the operations (where the arguments of functions are always non negative).

In the sequel of the paper, we will focus on some functions that can be finitely described, which is interesting from a computational point of view. Note that working with \mathbb{R} for values or arguments of the functions presents some issues. The main one is not the storage of the functions, which can be approximated with floats if e.g. they are piecewise affine, but rather the change of behavior of some operations. We will come back to this problem and see that the use of \mathbb{Q} instead of \mathbb{R} ensures good behaviors such as the preservation of nice asymptotic shapes.

These operations have some good behaviors when combined. For example, it is known that $\forall f, g, h \in \mathcal{D}$ or \mathcal{F} , as long as all the combinations below are defined over all \mathbb{R}_+ :

- $\min(f, g) * h = \min(f * h, g * h)$;
- $\min(f, g)^* = f^* * g^*$;
- $\max(f, g) \oslash h = \max(f \oslash h, g \oslash h)$;
- $f \oslash \min(g, h) = \max(f \oslash g, f \oslash h)$.

We will use some of these algebraic properties in our proofs and algorithms. Those properties are usually stated for non-negative and non-decreasing functions, but one can check from the definitions that they can be extended to \mathcal{D} and \mathcal{F} .

For a comprehensive survey on these properties, the reader is referred to Le Boudec and Thiran's book [Le Boudec and Thiran, 2001] as well as Chang's book [Chang, 2000]. A few other simple properties are listed in [Bouillard and Thierry, 2007b].

2.2 Classes of functions

Stability of classes. A class of functions is *closed* under some set of operations if combining members of the class with any of these operations outputs (if defined) a function which remains in the class. The *closure* of a class of functions under some set of operations is the smallest class containing these functions and closed under these operations.

Asymptotic behaviors.

Definition 1. Let f be a function from X into $\overline{\mathbb{R}}$ where $X = \mathbb{N}$ or \mathbb{R}_+ , then, with $X^* = X \setminus \{0\}$:

- f is affine if $\exists \sigma, \rho \in \mathbb{R}, \forall t \in X, f(t) = \rho t + \sigma$ or $\forall t \in X, f(t) = +\infty$ (resp. $-\infty$).
- f is ultimately affine if $\exists T \in X, \exists \sigma, \rho \in \mathbb{R}, \forall t > T, f(t) = \rho t + \sigma$ or $\forall t > T, f(t) = +\infty$ (resp. $-\infty$).
- f is pseudo-periodic if $\exists (c, d) \in \mathbb{R} \times X^*, \forall t \in X, f(t+d) = f(t) + c$.
- f is ultimately pseudo-periodic if $\exists T \in X, \exists (c, d) \in \mathbb{R} \times X^*, \forall t > T, f(t+d) = f(t) + c$.
- f is ultimately plain if $\exists T \in X, \forall t > T, f(t) \in \mathbb{R}$, or $\forall t > T, f(t) = +\infty$, or $\forall t > T, f(t) = -\infty$.
- f is plain if it is ultimately plain as above, and $\forall 0 \leq t < T, f(t) \in \mathbb{R}$, and $f(T) \in \mathbb{R}$ or possibly $f(T) = +\infty$ (resp. $-\infty$) in case $\forall t > T, f(t) = +\infty$ (resp. $-\infty$).

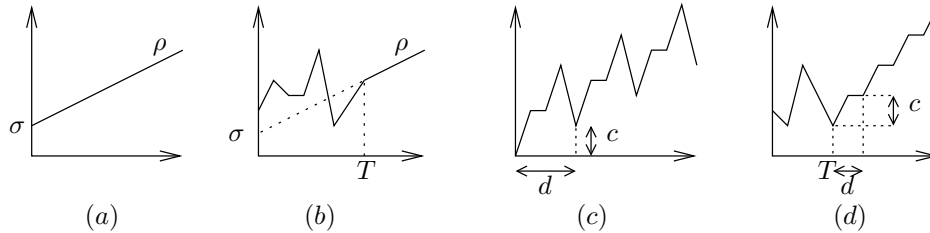

Figure 1: Classes of functions : (a) affine function; (b) ultimately affine function; (c) pseudo-periodic function; (d) ultimately pseudo-periodic function.

For affine and ultimately affine functions, ρ is the *growth rate*. For a pseudo-periodic function f , d is called a *period* of f , c is its associated *increment*, and *the period* of f is its smallest period (if different from 0). For an ultimately affine (resp. ultimately pseudo-periodic) function, we also say that it is ultimately affine (resp. ultimately pseudo-periodic) *from* T , and we say that T is a *rank* of the function. Given an ultimately pseudo-periodic function, there exists a smallest rank of pseudo-periodicity, called *the rank* of the function. More generally let $f, g \in \mathcal{F}$, we say that *ultimately* $f = g$ if $\exists T \in \mathbb{N}, \forall t > T, f(t) = g(t)$. Note that being plain is equivalent to have a support equal to $[0, T]$ or $[0, T[$ where $T \in \mathbb{R} \cup \{+\infty\}$. A non-decreasing function is always ultimately plain, and if $f(0) \in \mathbb{R}$, it is plain.

Remark 1. *An ultimately affine function is clearly ultimately plain and pseudo-periodic, and admits any $\varepsilon > 0$ as a period.*

Piecewise affine functions.

Definition 2. *We say that a function $f \in \mathcal{F}$ is piecewise affine if there exists an increasing sequence $(a_i)_{i \in \mathbb{N}}$ which tends to $+\infty$, such that $a_0 = 0$ and $\forall i \geq 0$, f is affine on $]a_i, a_{i+1}[$, i.e. $\forall t \in]a_i, a_{i+1}[$, $f(t) = +\infty$ or $\forall t \in]a_i, a_{i+1}[$, $f(t) = -\infty$ or $\exists \sigma_i, \rho_i \in \mathbb{R}$, $\forall t \in]a_i, a_{i+1}[$, $f(t) = \sigma_i + \rho_i t$. The (a_i) 's are called discontinuities.*

Let $f \in \mathcal{F}$ a piecewise affine function and $a \in \mathbb{R}_+$, the right limit of f at a is defined as $f(a+) = \lim_{t \rightarrow a, t > a} f(t)$ and the left limit of f at a is defined as $f(a-) = \lim_{t \rightarrow a, t < a} f(t)$. Those limits exist.

Let $X \subseteq \mathbb{R}_+$ and $Y \subseteq \mathbb{R}$, we denote by $\mathcal{F}[X, Y]$ the set of all piecewise affine functions in \mathcal{F} such that there exists a sequence $(a_i)_{i \in \mathbb{N}}$ with the properties above and satisfying $\forall i \geq 0$, $a_i \in X$ and $f(a_i), f(a_i+), f(a_i-) \in Y \cup \{-\infty, +\infty\}$.

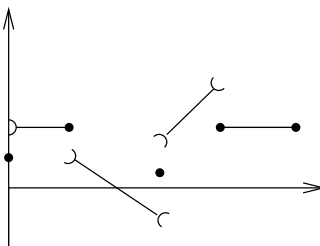

Figure 2: A piecewise affine function with respect to Definition 2.

Such functions are left-continuous (resp. right-continuous) if $\forall i \geq 0$, $f(a_i) = f(a_i-)$ (resp. $f(a_i) = f(a_i+)$).

We will mainly consider $\mathcal{F}[\mathbb{N}, \mathbb{R}]$, $\mathcal{F}[\mathbb{Q}_+, \mathbb{R}]$, $\mathcal{F}[\mathbb{R}_+, \mathbb{R}]$ or $\mathcal{F}[\mathbb{Q}_+, \mathbb{Q}]$.

Note that a piecewise affine function up to $T + d$ which is ultimately pseudo-periodic of period d from T is clearly piecewise affine with regard to Definition 2.

2.3 Links between discrete and fluid calculations

Let $f \in \mathcal{F}$, we denote by $[f]_{\mathbb{N}}$ its restriction on \mathbb{N} . Let $f \in \mathcal{D}$, we denote by $[f]_{\mathbb{R}}$ its *continuous* piecewise affine interpolation: $\forall n \in \mathbb{N}$, $[f]_{\mathbb{R}}(n) = f(n)$ and if $f(n), f(n+1) \in \mathbb{R}$, then $[f]_{\mathbb{R}}$ on $]n, n+1[$ is the affine interpolation between the two points, if $f(n) \in \mathbb{R}$ and $f(n+1) = +\infty$ (resp. $-\infty$), then $[f]_{\mathbb{R}}(t) = +\infty$ (resp. $-\infty$) on $]n, n+1[$ (do symmetrically if $f(n+1) \in \mathbb{R}$ and $f(n) = +\infty$ or $-\infty$), and if $f(n), f(n+1) \in \{-\infty, +\infty\}$, then $[f]_{\mathbb{R}}$ is equal to $f(n)$ on $]n, n + \frac{1}{2}[$ and $f(n+1)$ on $]n + \frac{1}{2}, n+1[$. Thus $[f]_{\mathbb{R}} \in \mathcal{F}[\mathbb{N}, \mathbb{R}]$.

Let \odot be a Network Calculus operation, we denote by $\odot_{\mathbb{R}}$ its version for functions in \mathcal{F} and by $\odot_{\mathbb{N}}$ its version for functions in \mathcal{D} . The difference is mainly for $*$, \otimes and the subadditive closure which use indices in the corresponding spaces, whereas the other operations are just point-wise operations.

The following lemma draws a first link between the discrete model and the fluid model: it provides a way to transfer results about calculations in \mathcal{F} to calculations in \mathcal{D} .

Proposition 1. *Let $f, g \in \mathcal{D}$, whenever $\odot = \min, \max, +, -, *, \otimes$, we have*

$$[[f]_{\mathbb{R}} \odot_{\mathbb{R}} [g]_{\mathbb{R}}]_{\mathbb{N}} = f \odot_{\mathbb{N}} g.$$

Moreover $[[f]_{\mathbb{R}}^*]_{\mathbb{N}} = f^*$.

Proof. The result is clear for the operations $\min, \max, +, -$, because the result of these operations at a point only depends on the values of the functions at that point.

Consider the operator $*$. The support of $[f]_{\mathbb{R}} *_{\mathbb{R}} [g]_{\mathbb{R}}$ is clearly a union of closed intervals of \mathbb{R}_+ . Let $t \in \mathbb{N}$, then $[f]_{\mathbb{R}} *_{\mathbb{R}} [g]_{\mathbb{R}}(t) = \inf_{0 \leq s \leq t} [f]_{\mathbb{R}}(s) + [g]_{\mathbb{R}}(t-s)$. Suppose that it has a finite value and that this minimum (this is a minimum because $s \mapsto [f]_{\mathbb{R}}(s) + [g]_{\mathbb{R}}(t-s)$ is continuous on the support within $[0, t]$ which is compact) is reached for $s_0 \notin \mathbb{N}$. Then $[f]_{\mathbb{R}} *_{\mathbb{R}} [g]_{\mathbb{R}}(t) = [f]_{\mathbb{R}}(s_0) + [g]_{\mathbb{R}}(t-s_0)$.

Let $\rho_f = f(\lceil s_0 \rceil) - f(\lfloor s_0 \rfloor)$ and $\rho_g = g(t - \lfloor s_0 \rfloor) - g(t - \lceil s_0 \rceil)$. If $\rho_f \geq \rho_g$ then

$$f(\lfloor s_0 \rfloor) + g(t - \lfloor s_0 \rfloor) \leq [f]_{\mathbb{R}}(s_0) + [g]_{\mathbb{R}}(t - s_0).$$

On the other hand, if $\rho_f \leq \rho_g$ then

$$f(\lceil s_0 \rceil) + g(t - \lceil s_0 \rceil) \leq [f]_{\mathbb{R}}(s_0) + [g]_{\mathbb{R}}(t - s_0).$$

In both cases, we could have taken $s_0 \in \mathbb{N}$. To find a value of $[f]_{\mathbb{R}} *_{\mathbb{R}} [g]_{\mathbb{R}}$ at an integer coordinate, it is sufficient to consider the functions $[f]_{\mathbb{R}}$ and $[g]_{\mathbb{R}}$ on their integer coordinates, which is the same as computing $f *_{\mathbb{N}} g$. In case $[f]_{\mathbb{R}} *_{\mathbb{R}} [g]_{\mathbb{R}}(t)$ is $+\infty$ or $-\infty$, it can be easily seen that the minimum can be also reached for an integer coordinate.

Using the same kind of reasoning gives the proof for the subadditive closure (with the characterization of Equation 1) and the deconvolution (choose s_0 as the index in \mathbb{R}_+ which approaches the supremum as close as we want). ■

However note that this correspondence only works for “depth 1” level of operations. Given a formula with functions in \mathcal{D} and operations over \mathbb{N} , doing all the calculations in \mathcal{F} with the interpolated functions and then going back to \mathcal{D} by restricting the output function to \mathbb{N} does not always provide the right result.

Example 1. Let $f : t \mapsto 3$ and $g : t \mapsto 2t$. Figure 3 gives on the left the result of the computation of $\max(f, g)$ in \mathbb{R} and in \mathbb{N} . Restricted to the natural numbers, the result of this computation is the same. But the result of $\max(f, g) * \max(f, g)$ on the right shows that the values for $t = 3$ differ.

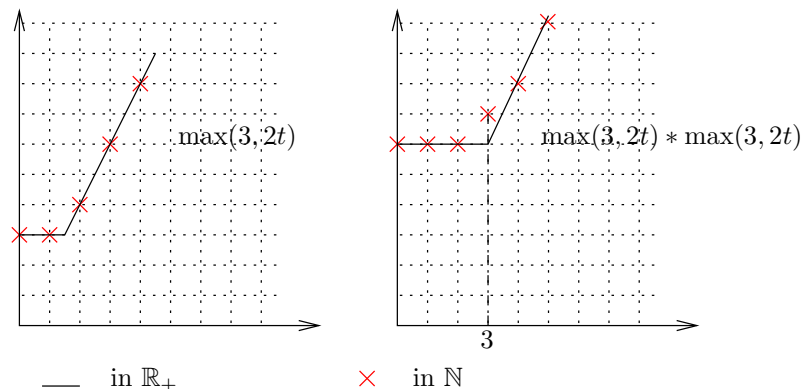

Figure 3: Computation of $\max(3, 2t) * \max(3, 2t)$ in \mathbb{R}_+ and in \mathbb{N} .

The continuity and the linearity of that piecewise affine interpolation on its support play an important role. Some other ways to interpolate functions defined on \mathbb{N} into functions defined on \mathbb{R}_+ , such as $f \mapsto \langle f \rangle_{\mathbb{R}}(t) = f(\lfloor t \rfloor)$ or $f \mapsto \langle f \rangle_{\mathbb{R}}(t) = f(\lceil t \rceil)$, do not yield the same general lemma (see [Bouillard and Thierry, 2007a] for examples).

3 Stability under Network Calculus operations

In this section, we give the proofs of the main theorems of this paper, that is the stability of the discrete functions and piecewise affine functions which are plain and ultimately pseudo-periodic.

Let us first give some additional notations.

For all $x \in \mathbb{R}$, we use the notation $x_+ = \max(0, x)$. By extension, let $f \in \mathcal{D}$ or \mathcal{F} , we denote by f_+ the function such that $f_+(t) = (f(t))_+$ for all t . For all $a, b \in \mathbb{N}$, and by extension for $a, b \in \mathbb{R}_+$ such that $a/b \in \mathbb{Q}$, we will denote by $\gcd(a, b)$ their greatest common divisor and $\text{lcm}(a, b)$ their lowest common multiple.

3.1 Stability of asymptotic behaviors.

We now study the behavior of the classes of affine, ultimately affine and ultimately pseudo-periodic functions. Unless specified, the following results are true for both the discrete model and the fluid model. Each result could be presented in both settings with corresponding proofs which would be identical. However some of the proofs are only stated for the fluid model, then one can refer to Proposition 1 to ensure that the same result holds for the discrete model.

To get rid of some special cases involved by infinite values, we first set the following lemma.

Lemma 1. *Let $f \in \mathcal{F}$ (resp. \mathcal{D}) such that $\exists a \in \mathbb{R}_+$ (resp. \mathbb{N}), $f(a) = -\infty$. Then for all $t \geq a$, $f^*(t) = -\infty$. Moreover for all $g \in \mathcal{F}$ (resp. \mathcal{D}), if $f * g$ is well defined, then $\forall t \geq a$, $(g * f)(t) = -\infty$.*

Let $g \in \mathcal{F}$ (resp. \mathcal{D}) such that $\exists t \in \mathbb{R}_+$ (resp. \mathbb{N}), $g(t) = -\infty$. If $f \circ g$ is well defined, $\forall t \geq 0$, $(f \circ g)(t) = +\infty$.

Proof. The proof is a direct application of the definitions of the operations. ■

3.1.1 Stability of plain and ultimately plain functions

Before addressing ultimate affine and pseudo-periodic behaviors, we state a proposition concerning plain and ultimately plain functions.

Proposition 2. *The classes of plain and ultimately plain functions in \mathcal{D} (resp. \mathcal{F}) are closed under \min , \max , $+$, $-$ and $*$, but not under \circ . Plain functions are closed under the subadditive closure, but ultimately plain functions are not.*

Proof. The result is a clear for \min , \max , $+$ and $-$. For the convolution, if f_1 (resp. f_2) is ultimately plain from T_1 (resp. T_2), then $f_1 * f_2$ is clearly ultimately plain from $T_1 + T_2$ (with

values either in \mathbb{R} or equal to $+\infty$ or equal to $-\infty$ depending of the ultimate values of f_1 and f_2 . Moreover, for plain functions, if the support of f_1 (resp. f_2) is $[0, T_1[, [0, T_1], \mathbb{N}$ or \mathbb{R}_+ (resp. $[0, T_2[, [0, T_2], \mathbb{N}$ or \mathbb{R}_+) then the support of $f_1 * f_2$ is clearly $[0, T_1 + T_2[, [0, T_1 + T_2], \mathbb{N}$ or \mathbb{R}_+ . For the subadditive closure, let $f \in \mathcal{D}$ (resp. \mathcal{F}) be plain, if $f(0) < 0$ then $f^* = -\infty$ over \mathbb{R}_+ , if $f = +\infty$ over \mathbb{R}_+ , then $f^* = f$ and the case of $\exists a \in \mathbb{R}_+, f(a) = -\infty$ is treated in Lemma 1. In all other cases, $f(1) \in \mathbb{R}$ (resp. $\exists \varepsilon > 0, \forall t \in [0, \varepsilon], f(t) \in \mathbb{R}$) and thus $\forall t \in \mathbb{R}_+, f^*(t) \in \mathbb{R}$.

We now illustrate the negative statements of the proposition. The subadditive closure of ultimately plain function is not necessarily ultimately plain: let $f \in \mathcal{D}$ (or \mathcal{F}) such that $f(t) = 0$ if $t = 2$ and $= +\infty$ otherwise, it is ultimately plain but $f^*(t) = 0$ if t is an even integer and $= +\infty$ otherwise, is not.

For the deconvolution, let $f \in \mathcal{D}$ (or \mathcal{F}) such that $f(t) = t$ if t is an odd integer and $= 0$ otherwise, a careful application of the definition of $f \circ f$ gives $(f \circ f)(t) = t$ if t is an even integer and $= +\infty$ otherwise. Although f is plain, this output is not ultimately plain. Note that with $[f]_{\mathbb{R}}$ being the affine interpolation of $f \in \mathcal{D}$ above, $[f]_{\mathbb{R}} \circ [f]_{\mathbb{R}}$ gives the same output (see [Bouillard and Thierry, 2007b]). ■

Non-decreasing functions f such that $f(0) \in \mathbb{R}$ are a particular case of plain functions which remain plain under all the Network Calculus operations since the deconvolution preserves the non-decrease [Le Boudec and Thiran, 2001].

3.1.2 Stability of the ultimately affine functions

It is easy to see that the affine functions are closed under $+$, $-$, $*$, \circ , but not under \min , \max and the subadditive closure (see [Bouillard and Thierry, 2007a]). We now deal with ultimately affine functions.

Proposition 3. *Let $f_1, f_2 \in \mathcal{F}$ two ultimately affine functions from respectively T_1 and T_2 such that $\forall t \geq T_i, f_i(t) = \rho_i t + \sigma_i$, with $\rho_i, \sigma_i \in \mathbb{R}$. then:*

1. $\min(f_1, f_2)$ is ultimately affine from $T = \max(T_1, T_2, \frac{\sigma_1 - \sigma_2}{\rho_2 - \rho_1})$ if $\rho_1 \neq \rho_2$ and from $\max(T_1, T_2)$ otherwise, and its rate is $\min(\rho_1, \rho_2)$,
2. $\max(f_1, f_2)$ is ultimately affine from $T = \max(T_1, T_2, \frac{\sigma_1 - \sigma_2}{\rho_2 - \rho_1})$ if $\rho_1 \neq \rho_2$ and from $\max(T_1, T_2)$ otherwise, and its rate is $\max(\rho_1, \rho_2)$,
3. $f_1 + f_2$ is ultimately affine from $\max(T_1, T_2)$, with rate $\rho_1 + \rho_2$,
4. $f_1 - f_2$ is ultimately affine from $\max(T_1, T_2)$, with rate $\rho_1 - \rho_2$,

5. $f_1 * f_2$ is ultimately affine from $T_1 + T_2$ if $\rho_1 = \rho_2$ and from $\max(T_1 + T_2, T')$ with $T' = \frac{\sigma_1 - \sigma_2}{\rho_2 - \rho_1} + \frac{\inf_{0 \leq u \leq T_2} (f_2(u) - \rho_1 u) - \inf_{0 \leq s \leq T_1} (f_1(s) - \rho_2 s)}{\rho_2 - \rho_1}$ if $\rho_1 < \rho_2$ and in both cases its rate is $\min(\rho_1, \rho_2)$ (unless $\exists t \geq 0$, $f_1(t)$ or $f_2(t) = -\infty$, then it is equal to $-\infty$ from $T_1 + T_2$).

6. $f_1 \otimes f_2$ is ultimately affine from T_1 , with rate ρ_1 (unless $\exists t \geq 0$, $f_2(t) = -\infty$, then it is equal to $+\infty$ from 0).

To deal with functions which are ultimately infinite, consider that $f_1 = +\infty$ (resp. $-\infty$) from T_1 is equivalent to $\rho_1 = +\infty$ (resp. $-\infty$), idem for f_2 and apply the cases above. Moreover if f_1 and f_2 are plain, then all the outputs are also plain.

Proof.

1. (and 2.) Suppose first that f_1 and f_2 are both affine: $f_i(t) = \rho_i t + \sigma_i$, $i = 1, 2$. If $\rho_1 \neq \rho_2$, then there exists a unique point t_0 such that $f_1(t_0) = f_2(t_0)$, and $t_0 = \frac{\sigma_2 - \sigma_1}{\rho_1 - \rho_2}$. If $\rho_1 = \rho_2$, then $\min(f_1, f_2)$ is either f_1 if $\sigma_1 \leq \sigma_2$, or f_2 otherwise.

If f_1 and f_2 are ultimately affine, then it is easy to see that $\min(f_1, f_2)$ is ultimately affine from $T = \max(T_1, T_2, \frac{\sigma_2 - \sigma_1}{\rho_1 - \rho_2})$ if $\rho_1 \neq \rho_2$ or $T = \max(T_1, T_2)$ if $\rho_1 = \rho_2$.

Note that T may be arbitrarily large if ρ_1 and ρ_2 are close.

3. (and 4.) Clear since adding two affine functions remains affine.

5. Let $t \geq T_1 + T_2$. Let us calculate $f_1 * f_2(t)$:

$$\begin{aligned}
f_1 * f_2(t) &= \inf_{0 \leq s \leq t} f_1(s) + f_2(t - s) \\
&= \inf_{0 \leq s \leq T_1} f_1(s) + f_2(t - s) \oplus \inf_{T_1 \leq s \leq t - T_2} f_1(s) + f_2(t - s) \oplus \inf_{t - T_2 \leq s \leq t} f_1(s) + f_2(t - s) \\
&= \inf_{0 \leq s \leq T_1} (f_1(s) + f_2(t - s)) \oplus \inf_{T_1 \leq s \leq t - T_2} (f_1(s) + f_2(t - s)) \oplus \inf_{0 \leq u \leq T_2} (f_1(t - u) + f_2(u)) \\
&= \inf_{0 \leq s \leq T_1} (f_1(s) + \rho_2(t - s) + \sigma_2) \oplus \inf_{T_1 \leq s \leq t - T_2} (\rho_1 s + \sigma_1 + \rho_2(t - s) + \sigma_2) \\
&\oplus \inf_{0 \leq u \leq T_2} (\rho_1(t - u) + \sigma_1 + f_2(u)).
\end{aligned}$$

The infimum over $T_1 \leq s \leq t - T_2$ of the second term is taken for an affine function. Thus it is reached for $s = T_1$ or $s = t - T_2$, and then it is equal to $f_1(T_1) + f_2(t - T_1)$ (or $f_1(t - T_2) + f_2(T_2)$) which is larger than the first term (or the third term) since it is the value when $s = T_1$ (or $s = t - T_2$) in the infimum over $0 \leq s \leq T_1$ (or $t - T_2 \leq s \leq t$). We can simplify the formula by removing the second term and we have:

$$f_1 * f_2(t) = \rho_2 t + \sigma_2 + \inf_{0 \leq s \leq T_1} (f_1(s) - \rho_2 s) \oplus \rho_1 t + \sigma_1 + \inf_{0 \leq u \leq T_2} (f_2(u) - \rho_1 u).$$

Let $m_2 = \inf_{0 \leq s \leq T_1} (f_1(s) - \rho_2 s)$ and $m_1 = \inf_{0 \leq u \leq T_2} (f_2(u) - \rho_1 u)$. We have $m_1, m_2 < +\infty$

since $f_1(T_1) = \rho_1 T_1 + \sigma_1 \in \mathbb{R}$ and $f_2(T_2) = \rho_2 T_2 + \sigma_2 \in \mathbb{R}$. We have $\forall t \geq T_1 + T_2$, $f_1 * f_2(t) = \rho_2 t + \sigma_2 + m_2 \oplus \rho_1 t + m_1$ and are back to the case of the minimum of two affine functions.

6. $\forall t \geq T_1$,

$$\begin{aligned} f_1 \circ f_2(t) &= \sup_{s \geq 0} (f_1(t+s) - f_2(s)) \\ &= \sup_{s \geq 0} (\sigma_1 + \rho_1(t+s) - f_2(s)) = \sigma_1 + \rho_1 t + \sup_{s \geq 0} (\rho_1 s - f_2(s)). \end{aligned}$$

As $\sup_{s \geq 0} (\rho_1 s - f_2(s))$ is a constant, $f_1 \circ f_2$ is ultimately affine from T_1 with a behavior which depends on the finiteness of $\sup_{s \geq 0} (\rho_1 s - f_2(s))$.

To check the preservation of the plain property under \circ (not guaranteed by Proposition 2), we also use that f_2 is ultimately affine. When $\rho_1 > \rho_2$, for any fixed $t \geq 0$, $f_1(t+s) - f_2(s) \rightarrow +\infty$ when $s \rightarrow +\infty$, and thus $(f_1 \circ f_2)(t) = +\infty$. Suppose now that $\rho_1 \leq \rho_2$. When $t+s \geq T_1$ and $s \geq T_2$, the difference $f_1(t+s) - f_2(s) = \rho_1(t+s) + \sigma_1 - \rho_2 s - \sigma_2$ is non-increasing when s increases. Thus $(f_1 \circ f_2)(t) = \sup_{0 \leq s \leq \max(T_2, T_1 - t)} (f_1(t+s) - f_2(s)) \in \mathbb{R}$ since f_1 and f_2 are plain.

To deal with ultimately infinite functions, apply the same reasoning with straight simplifications and check that the results correspond to the statements of the proposition with ρ_1 or ρ_2 appropriately associated with $+\infty$ or $-\infty$. The statement about plain functions is a consequence of Proposition 2, except for \circ . ■

Remark 2. *The subadditive closure of an ultimately affine function is not always ultimately affine, such an example is presented in [Le Boudec and Thiran, 2001], Chapter 3, for some $\beta_{R,T} + K$ functions defined on \mathbb{R}_+ . Another example is depicted in Figure 4. Let f be the function defined on \mathbb{N} by*

$$f(t) = \begin{cases} t & \text{if } t = 0 \text{ or } 1, \\ t - 1 & \text{if } t \geq 2 \end{cases}$$

and represented in Figure 4. Then f^* is not ultimately affine: an easy computation gives

$$f^*(t) = \begin{cases} t/2 & \text{if } t \text{ is even,} \\ (t+1)/2 & \text{if } t \text{ is odd.} \end{cases} \quad (2)$$

One can notice that f^* is pseudo-periodic of period 2.

3.1.3 Stability of the ultimately pseudo-periodic functions

Before considering pseudo-periodicity, we define a local finiteness property for functions in the fluid model.

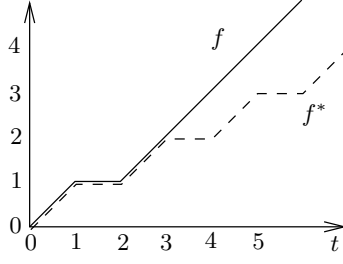

Figure 4: f is ultimately affine but f^* is not.

Definition 3. A function $f \in \mathcal{F}$ is locally bounded if f is bounded over any bounded subset of its support.

For instance, this property is not satisfied by $f(t) = 1/(1-t)$ on $[0, 1[$ and $= +\infty$ on $[1, +\infty[$. Piecewise affine functions are an example of locally bounded functions.

Proposition 4. Let $f_1, f_2 \in \mathcal{F}$ two ultimately plain pseudo-periodic functions from respectively T_1 and T_2 , with respective periods d_1 and d_2 and respective increments c_1 and c_2 . Suppose that they are both locally bounded, that $d_1/d_2 \in \mathbb{Q}$ and that $\forall t \geq T_i, f_i(t) \in \mathbb{R}, i \in \{1, 2\}$. Then

1. $\min(f_1, f_2)$ is locally bounded and ultimately plain pseudo-periodic. If $\frac{c_1}{d_1} < \frac{c_2}{d_2}$, then ultimately $\min(f_1, f_2) = f_1$ (period d_1 , increment c_1). If $\frac{c_2}{d_2} < \frac{c_1}{d_1}$, then ultimately $\min(f_1, f_2) = f_2$ (period d_2 , increment c_2). Otherwise, the period is $d = \text{lcm}(d_1, d_2)$ and the increment is $\frac{c_1}{d_1}d$.
2. $\max(f_1, f_2)$ is locally bounded and ultimately plain pseudo-periodic. If $\frac{c_1}{d_1} < \frac{c_2}{d_2}$, then ultimately $\max(f_1, f_2) = f_2$ (period d_2 , increment c_2). If $\frac{c_2}{d_2} < \frac{c_1}{d_1}$, then ultimately $\max(f_1, f_2) = f_1$ (period d_1 , increment c_1). Otherwise, the period is $d = \text{lcm}(d_1, d_2)$ and the increment is $\frac{c_1}{d_1}d$.
3. $f_1 + f_2$ is locally bounded and ultimately plain pseudo-periodic from $T = \max(T_1, T_2)$, with period $d = \text{lcm}(d_1, d_2)$, and increment $c = (\frac{c_1}{d_1} + \frac{c_2}{d_2})d$.
4. $f_1 - f_2$ is locally bounded and ultimately plain pseudo-periodic from $T = \max(T_1, T_2)$, with period $d = \text{lcm}(d_1, d_2)$, and increment $c = (\frac{c_1}{d_1} - \frac{c_2}{d_2})d$.
5. $f_1 * f_2$ is locally bounded and ultimately plain pseudo-periodic with period $d = \text{lcm}(d_1, d_2)$ and increment $\min(\frac{c_1}{d_1}, \frac{c_2}{d_2})d$.
6. $f_1 \circ f_2$ is locally bounded and ultimately plain pseudo-periodic from T_1 with period d_1 and increment c_1 .

To deal with functions which are ultimately infinite, consider that $f_1 = +\infty$ (resp. $-\infty$) from T_1 is equivalent to $c_1 = +\infty$ (resp. $-\infty$), idem for c_2 and apply the cases above. Moreover if f_1 and f_2 are plain, then all the outputs are also plain.

Proof. Let f_1 and f_2 be two ultimately plain pseudo-periodic functions s.t. $\forall t \geq T_i, f_i(t + d_i) = f_i(t) + c_i, i \in \{1, 2\}$. Let $d = \text{lcm}(d_1, d_2), c'_1 = \frac{c_1}{d_1}d$ and $c'_2 = \frac{c_2}{d_2}d$. The functions f_1 and f_2 are both ultimately pseudo-periodic of period d and with respective increment c'_1 and c'_2 .

1. (and 2.) First $\forall t \geq \max(T_1, T_2), f_i(t + d) = f_i(t) + c'_i$ and

$$\min(f_1, f_2)(t + d) = \min(f_1(t + d), f_2(t + d)) = \min(f_1(t) + c'_1, f_2(t) + c'_2).$$

If $c'_1 = c'_2$, then $\forall t \geq \max(T_1, T_2), \min(f_1, f_2)(t + d) = \min(f_1, f_2)(t) + c'_1$. It is clear that $\min(f_1, f_2)$ remains locally bounded and ultimately plain like f_1 and f_2 (note that in this case, we did not use those hypotheses to prove the ultimate pseudo-periodicity).

Otherwise, suppose without loss of generality that $c'_1 < c'_2$. Let $M_1 = \sup_{T_1 \leq t < T_1 + d_1} (f_1(t) - \rho_1 t)$ with $\rho_1 = \frac{c_1}{d_1} = \frac{c'_1}{d}$, then $M_1 < +\infty$ since f_1 is locally bounded and finite from T_1 . We have $\forall t \geq T_1, f_1(t) \leq \rho_1 t + M_1$. Let $m_2 = \inf_{T_2 \leq t < T_2 + d_2} (f_2(t) - \rho_2 t)$, then $m_2 > -\infty$ and $\forall t \geq T_2, f_2(t) \geq \rho_2 t + m_2$. As soon as $t \geq \max(T_1, T_2)$ and $\rho_1 t + M_1 \leq \rho_2 t + m_2$, that is to say $t \geq T = \frac{M_1 - m_2}{\rho_2 - \rho_1}$, we have $\min(f_1(t), f_2(t)) = f_1(t)$. Thus $\min(f_1, f_2)$ is ultimately plain and pseudo-periodic from $\max(T_1, T_2, T)$. It is also clearly locally bounded.

3. (and 4.) $\forall t \geq \max(T_1, T_2),$

$$(f_1 + f_2)(t + d) = f_1(t) + \frac{c_1}{d_1}d + f_2(t) + \frac{c_2}{d_2}d = (f_1 + f_2)(t) + \left(\frac{c_1}{d_1} + \frac{c_2}{d_2}\right)d.$$

Moreover being locally bounded and ultimately plain is clearly preserved for $+$.

5. First decompose each function into a transient part and a pseudo-periodic part, namely $f_1 = f'_1 \oplus f''_1$ where $f'_1 = f_1$ on $[0, T_1[$ and $= +\infty$ elsewhere, and $f''_1 = f_1$ on $[T_1, +\infty[$ and $= +\infty$ elsewhere. The function f_2 is decomposed in the same way into $f_2 = f'_2 \oplus f''_2$ with respect to T_2 . Then $f_1 * f_2 = f'_1 * f'_2 \oplus f'_1 * f''_2 \oplus f''_1 * f'_2 \oplus f''_1 * f''_2$.

The first term $f'_1 * f'_2$ is clearly equal to $+\infty$ from $T_1 + T_2$. The second term can be written for all $t \geq 0, f'_1 * f''_2(t) = \inf_{0 \leq s < T_1} (f_1(s) + f_2(t - s))$.

When $t \geq T_1 + T_2$, if $0 \leq s < T_1$, then $t - s \geq T_2$, thus

$$\begin{aligned} f'_1 * f''_2(t + d_2) &= \inf_{0 \leq s < T_1} (f_1(s) + f_2(t + d_2 - s)) \\ &= \inf_{0 \leq s < T_1} (f_1(s) + f_2(t - s)) + c_2 = f'_1 * f''_2(t) + c_2. \end{aligned}$$

The function $f'_1 * f''_2$ is pseudo-periodic from $T_1 + T_2$ with period d_2 and increment c_2 . The symmetrical result holds for $f''_1 * f'_2$.

To study the last term, let $t \geq T_1 + T_2 + d$ (this bound is necessary for the second equality below), then

$$\begin{aligned}
f''_1 * f''_2(t + d) &= \inf_{T_1 \leq s \leq t + d - T_2} (f_1(s) + f_2(t + d - s)) \\
&= \inf_{T_1 \leq s \leq t - T_2} (f_1(s) + f_2(t + d - s)) \oplus \inf_{T_1 + d \leq s \leq t + d - T_2} (f_1(s) + f_2(t + d - s)) \\
&= \inf_{T_1 \leq s \leq t - T_2} (f_1(s) + f_2(t + d - s)) \oplus \inf_{T_2 \leq u \leq t - T_1} (f_1(t + d - u) + f_2(u)) \\
&= \inf_{T_1 \leq s \leq t - T_2} (f_1(s) + f_2(t - s) + c'_2) \oplus \inf_{T_2 \leq u \leq t - T_1} (f_1(t - u) + f_2(u) + c'_1) \\
&= \min(f''_1 * f''_2(t) + c'_2, f''_1 * f''_2(t) + c'_1) \\
&= f''_1 * f''_2(t) + \min(c'_1, c'_2)
\end{aligned}$$

Thus $f''_1 * f''_2$ is pseudo-periodic from $T_1 + T_2 + d$, with period d and increment $\min(c'_1, c'_2)$.

Now we state that these four terms are locally bounded. Since f_1 and f_2 are locally bounded, f'_1, f''_1, f'_2, f''_2 are also locally bounded. Then remark that the convolution $f * g$ of two locally bounded functions f, g is always locally bounded. Let $A \in \mathbb{R}_+, \forall t \in [0, A], f * g(t)$ only depends on the restriction of f and g on $[0, A]$ for which $\exists M_f, M_g \in \mathbb{R}_+$ such that $f(s) \in \mathbb{R} \implies |f(s)| \leq M_f$ and $g(s) \in \mathbb{R} \implies |g(s)| \leq M_g$. Thus $\forall t \in [0, A], f * g(t) \in \mathbb{R} \implies |f * g(t)| \leq M_f + M_g$. It applies to our four terms which are consequently locally bounded.

Next it can be easily checked from their definitions as infima that the four terms are ultimately plain. It ensures that their minimum is ultimately plain and pseudo-periodic: $f_1 * f_2$ is ultimately plain pseudo-periodic with period d and increment $\min(c'_1, c'_2)$.

6. $\forall t \geq T_1,$

$$\begin{aligned}
f_1 \circ f_2(t + d_1) &= \sup_{s \geq 0} (f_1(t + d_1 + s) - f_2(s)) = \sup_{s \geq 0} (f_1(t + s) + c_1 - f_2(s)) \\
&= c_1 + \sup_{s \geq 0} (f_1(t + s) - f_2(s)) = c_1 + f_1 \circ f_2(t).
\end{aligned}$$

So we get the ultimate pseudo-periodicity just by using the ultimate pseudo-periodicity of f_1 , in particular no assumption on f_2 is necessary. On the contrary, remaining locally bounded and plain or ultimately plain requires some further assumptions of the proposition.

Remark that if $c'_1 > c'_2$, then $\forall t \in \mathbb{R}_+, f_1 \circ f_2(t) = +\infty$. Otherwise if $c'_1 \leq c'_2$, then $\forall t \in [0, T_1 + d_1[, \sup_{s \geq 0} (f_1(t + s) - f_2(s))$ is clearly reached when $s \leq \max(T_1, T_2) + d = T$. It first implies that if f_1 and f_2 are locally bounded then $f_1 \circ f_2$ is bounded on its support in $[0, T_1 + d_1[$. Thanks to pseudo-periodicity, it extends to any bounded part of the support and $f_1 \circ f_2$ is locally

bounded. In addition, since the supremum is reached over $[0, T]$ which does not depend on T and thanks to pseudo-periodicity, $f_1 \circledast f_2$ is ultimately plain (resp. plain) as soon as f_1 is ultimately plain (resp. plain).

To deal with ultimately infinite functions, apply the same reasoning with straightforward simplifications and check that the results correspond to the statements of the proposition with increments appropriately associated with $+\infty$ or $-\infty$. The statement about plain functions is a consequence of Proposition 2, except for \circledast .

Note that all the values of ranks considered in the proof still apply if we use ranks with strict inequalities as in their initial definition, i.e. if we start with $f_i(t) \in \mathbb{R}$ and $f_i(t + d_i) = f_i(t) + c_i$, $\forall t > T_i$ instead of $\forall t \geq T_i$. ■

Remark that the hypothesis of locally bounded and ultimate plain functions is necessary to ensure pseudo-periodicity (see [Bouillard and Thierry, 2007a]).

If we restrict all the previous results to functions in \mathcal{D} , we can almost state our first stability result. The next proposition achieves that for the last operation, namely the subadditive closure. Note that its proof is specially designed for functions in \mathcal{D} . In Subsection 3.2, we will propose another proof for the fluid model yielding the result in \mathcal{D} as a corollary. The two proofs are essentially different, so we choose to keep them both.

Proposition 5. *Let $f \in \mathcal{D}$ be an ultimately pseudo-periodic function, then f^* is ultimately pseudo-periodic.*

Proof. Let $f \in \mathcal{D}$ be an ultimately pseudo-periodic function such that $\forall t \geq T$, $f(t + d) = f(t) + c$, with $c \in \mathbb{R}$. This includes the ultimately affine functions in \mathcal{D} , which have period 1. We dismiss the cases when $f(0) < 0$ or when $f = +\infty$ over all \mathbb{N} , for which the result is clear. The subadditive closure f^* is given by Equation 1:

$$f^*(t) = \inf_{k \in \mathbb{N}} \min_{t_1 + \dots + t_k = t, t_1, \dots, t_k \in \mathbb{N}^*} f(t_1) + \dots + f(t_k).$$

The idea of the proof is to use the $(\min, +)$ matrix theory. We first build a directed weighted graph $G = (N, A, W)$ in the following way:

- $N = \{1, \dots, T + d - 1\}$ is the set of vertices;
- $\forall i \in \{1, \dots, T + d - 2\}$ put an arc from node i to node $i + 1$ of weight 0 (i.e. $W(i, i + 1) = 0$);
- $\forall i \in N$, put an arc from node i to node 1 of weight $f(i)$ (i.e. $W(i, 1) = f(i)$);
- put an arc from node $T + d - 1$ to node T of weight c (i.e. $W(T + d - 1, T) = c$).

The construction is illustrated by Figure 5.

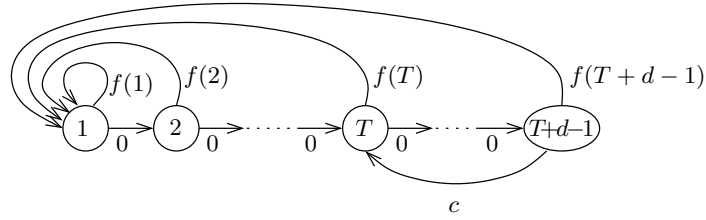

Figure 5: From the function f to a directed graph.

The graph G is strongly connected and if we only consider arcs with weight $< +\infty$, the new graph either remains G if $\exists t \geq T$, $f(t) < +\infty$, or has a unique strongly connected component on nodes $\{1, \dots, T_0\}$ where $T_0 = \min\{t_0 \mid \forall t > t_0, f(t) = +\infty\}$. Let $i \in \mathbb{N}$, by construction, there is exactly one path from node 1 to itself of length i that does not visit node 1 except at the beginning and at the end of the path. The weight of that path is $f(i)$. Now, consider a path from node 1 to itself. That path is a union of paths from 1 to itself. If the length of that path is t , there exists a decomposition of t , $t = t_1 + \dots + t_k$ such that the weight of the path is $f(t_1) + \dots + f(t_k)$. Conversely, for every t_1, \dots, t_k , there is a path from 1 to itself of length $t_1 + \dots + t_k$ of weight $f(t_1) + \dots + f(t_k)$.

Let A be the $(\min, +)$ matrix associated to G (i.e. $A_{i,j} = \min(+\infty, W(i, j))$). The matrix A is irreducible (or has a unique irreducible submatrix containing coefficient 1,1) and for every $t \in \mathbb{N}$, $f^*(t) = A_{1,1}^t$. Let d^* be its cyclicity and λ be its unique $(\min, +)$ eigenvalue. According to the Fundamental Theorem of the $(\min, +)$ matrices [Baccelli et al., 1992] (Section 3.7, page 143-151), there exists a rank T^* such that $\forall t \geq T^*$, $A^{t+d^*} = A^t + \lambda d^*$. Then, $f^*(t + d^*) = f^*(t) + \lambda d^* = f^*(t) + c^*$ with $c^* = \lambda d^*$. Then f^* is ultimately pseudo-periodic of period d^* and increment c^* .

More precisely, the eigenvalue $\lambda = c^*/d^*$ of A is the minimal average weight of a circuit of G . By construction, this is equal to $\min(c/d, \min_{1 \leq t \leq T+d-1} f(t)/t)$ (note that it is also $\inf_{t \in \mathbb{N}^*} f(t)/t$). Consider the vertices and edges of the circuits achieving λ . It yields a subgraph of G called the critical graph and denoted G^c . The cyclicity d^* is the lcm of the gcd of the lengths of the circuits of each strongly connected component of G^c . Consider $S = \{t \in \{1, \dots, T+d-1\} \mid \frac{f(t)}{t} = \lambda\}$ the arguments reaching the minimum (if there are some). Then

- If $\frac{c}{d} > \lambda$, the critical graph is the induced graph over vertices $\{1, \dots, \max(S)\}$ and $d^* = \gcd(S)$.
- If $\frac{c}{d} = \lambda$ and $S = \emptyset$, the critical graph is a single circuit and $d^* = d$.

- If $\frac{c}{d} = \lambda$ and $S \cap \{T, \dots, T + d - 1\} \neq \emptyset$, the critical graph is G and $d^* = \gcd(S \cup \{d\})$.
- If $\frac{c}{d} = \lambda$ and $S \subseteq \{1, \dots, T - 1\}$, the critical graph has two strongly connected components and $d^* = \text{lcm}(d, \gcd(S))$. In this later case, one can give a tighter period for f^* by proving that $\gcd(S)$ works. It is known that if an ultimately pseudo-periodic function admits two periods d_1 and d_2 (possibly from different ranks), then it also admits $\gcd(d_1, d_2)$ as a period. Thus it is sufficient to prove that for all $s \in S$, f^* admits s as a period. Let $s \in S$, then by definition $\forall t \geq 0, f^*(t + s) \leq f^*(t) + f(s) = f^*(t) + \lambda s$. Since s divides $d^* = \text{lcm}(d, \gcd(S))$, we have $\forall t \geq 0, f^*(t) \geq f^*(t + s) - \lambda s \geq f^*(t + 2s) - 2\lambda s \geq \dots \geq f^*(t + d^*) - \lambda d^*$. When $t \geq T^*$, $f^*(t + d^*) = f^*(t) + \lambda d^*$ which means that all these inequalities are equalities. It implies that $\forall t \geq T^*, f^*(t + s) = f^*(t) + \lambda s$ and thus s is a period of f^* .

■

Computational considerations will be discussed in Subsection 4. Now we can state our first stability theorem: it is a direct consequence of Proposition 2, Proposition 4 and Proposition 5 for the discrete model.

Theorem 1. *The class of plain ultimately pseudo-periodic functions of \mathcal{D} is stable under the Network calculus operations, that is $+$, $-$, \min , \max , $*$, \odot and the subadditive closure.*

Remark 3. *Weakening the property plain by ultimately plain does not ensure that compositions will preserve the ultimate pseudo-periodicity. As a mix of previous remarks, let $f(t) = 0$ if $t = 2$ and $+\infty$ elsewhere, and $g(t) = 3$ if $t = 3$ and $+\infty$ elsewhere, which are both ultimately plain.*

Then

$$\min(f^*, g^*)(t) = \begin{cases} 0 & \text{if } t = 6k, 6k + 2 \text{ or } 6k + 4, k \in \mathbb{N} \\ t & \text{if } t = 6k + 3, k \in \mathbb{N} \\ +\infty & \text{otherwise.} \end{cases}$$

This function is not ultimately pseudo-periodic.

A careful look at previous references reveals that an important part of this theorem, namely the stability under \min , $*$ and the subadditive closure, was already known for some non-decreasing functions, but mainly stated in terms of (γ, δ) formal power series, and in a $(\max, +)$ framework instead of $(\min, +)$ which has no consequence on the result. Those power series are for instance used to describe precisely the dynamics of some Petri nets. The reader is referred to Baccelli et al's book [Baccelli et al., 1992]: Theorem 5.39, page 255, involves the stability result for non-decreasing functions from \mathbb{N} into $\overline{\mathbb{N}}$. Some extensions are also given in Chapter 6, like

Theorem 6.32, Remark 6.33 and Corollary 6.34, page 290-291, which imply stability results for some non-decreasing fluid functions. For detailed proofs and algorithmic design, see also Gaubert's thesis [Gaubert, 1992]. Even if the underlying mathematics are the same, it is not clear for us yet whether the stability of non-decreasing functions from \mathbb{N} into $\overline{\mathbb{R}}$ (under \min , $*$ and the sub-additive closure) or the stability without imposing non-decrease can be directly deduced from all these theorems and proofs. We will mention in Subsection 3.2 the extensions to fluid functions presented in [Baccelli et al., 1992].

3.2 Stability of some piecewise affine classes

Whereas in the discrete model, the combination of functions in \mathcal{D} clearly outputs (when defined) a function in \mathcal{D} (meaning that \mathcal{D} is closed under Network Calculus operations), such a result needs a proof for piecewise affine functions of the fluid model.

Proposition 6. *The classes $\mathcal{F}[\mathbb{R}_+, \mathbb{R}]$ and $\mathcal{F}[\mathbb{Q}_+, \mathbb{Q}]$ are stable under the operations $+$, $-$, \min , \max .*

Proof. Trivial. Just observe that two affine functions from \mathbb{Q}_+ into \mathbb{Q} intersect at a rational point. ■

The class $\mathcal{F}[\mathbb{Q}_+, \mathbb{R}]$ is also stable under $+$, $-$. However it is false under \min or \max , *e.g.* consider $\forall t \in \mathbb{R}_+$, $f(t) = \sqrt{2}t$ and $g(t) = 1$, both f and g belong to $\mathcal{F}[\mathbb{Q}_+, \mathbb{R}]$ but $\min(f, g)(t) = \sqrt{2}t$ on $[0, 1/\sqrt{2}]$ and $= 1$ on $]1/\sqrt{2}, +\infty[$ does not belong to $\mathcal{F}[\mathbb{Q}_+, \mathbb{R}]$ because $1/\sqrt{2} \notin \mathbb{Q}_+$.

Definition 4 (Spots and segments).

- For $a \in \mathbb{R}_+$, a function $f \in \mathcal{F}$ is a spot on a if $\forall t \in \mathbb{R}_+ \setminus \{a\}$, $f(t) = +\infty$ and $f(a) \neq +\infty$.
- For $a, b \in \mathbb{R}_+$, $a < b$, a function $f \in \mathcal{F}$ is a segment on $]a, b[$ if $\exists \sigma, \rho \in \mathbb{R}$ such that $f(t) = \rho(t - a) + \sigma$ if $t \in]a, b[$ and $= +\infty$ otherwise. We call $]a, b[$ the support of f , σ and ρ are called the parameters of f , ρ is called the slope.
- With the same notation, if the support is $]a, b]$ or $[a, b[$ (resp. $[a, b]$), f is called a semi-closed (resp. closed) segment.
- For $T \in \mathbb{R}_+$, $c \in \mathbb{R}$ and $d \in \mathbb{R}_+^*$, a function f is an iterated spot from T with period d and increment c if $\forall i \in \mathbb{N}$, $f(T + id) = f(T) + ic$, and $f(t)$ is $+\infty$ elsewhere.
- For $T \in \mathbb{R}_+$, $c \in \mathbb{R}$ and $d \in \mathbb{R}_+^*$, a function $f \in \mathcal{F}$ is an iterated segment from T , with period d and increment c and slope ρ if $\exists a \in \mathbb{R}_+^*$, $\exists f(T+), \sigma \in \mathbb{R}$ such that $a \leq d$ and $\forall i \in \mathbb{N}$,

on the interval $]T+id, T+id+a[$, f is affine with $\forall t \in]0, a[$, $f(T+id+t) = f(T+) + ic + \rho t$, and on all other intervals f is $+\infty$.

Iterated segments and spots are the ultimately pseudo-periodic versions of segments and spots.

Any piecewise affine function can be decomposed into spots and segments.

Definition 5. Let $f \in \mathcal{F}[\mathbb{R}_+, \mathbb{R}]$ with discontinuities $(a_n)_{n \in \mathbb{N}}$. Let f_{2n+1} be the segment of support $]a_n, a_{n+1}[$, $n \geq 0$ that is equal to f on that interval and f_{2n} be the spot on a_n with value $f(a_n)$. Then, $f = \inf_{n \in \mathbb{N}} f_n$. We call the sequence $(f_n)_{n \in \mathbb{N}}$ the elementary decomposition of f .

That decomposition is very useful to show the stability of the piecewise affine functions by the Network Calculus operations.

3.2.1 Stability for the convolution

Lemma 2 (Convolution of spots). Let f_1 and f_2 be two spots respectively on a and b . Then $f_1 * f_2$ is a spot on $a + b$ and $f_1 * f_2(a + b) = f_1(a) + f_2(b)$.

Lemma 3 (Convolution of a spot and a segment). Let f_1 be a segment on $]a, b[$ and f_2 be a spot on c . Then, $f_1 * f_2$ is a segment on $]a + c, b + c[$ and $\forall t \in]a, b[$, $f_1 * f_2(c + t) = f_1(t) + f_2(c)$.

Proof. By definition, $f_1 * f_2(t) = \inf_{0 \leq s \leq t} f_1(s) + f_2(t - s)$. As f_2 is a spot, $f_2(t - s) \neq \infty$ if and only if $t - s = c$, so that $s = t - c$. As a consequence, $f_1 * f_2(t) = f_1(t - c) + f_2(c)$, which is finite if and only if $t \in]a + c, b + c[$. ■

Lemma 4 (Convolution of segments [Le Boudec and Thiran, 2001]). Let $f_1, f_2 \in \mathcal{F}$ be two segments on respectively $]a, b[$ and $]c, d[$ with respective slopes ρ_1 and ρ_2 such that $\rho_1 \leq \rho_2$. Then $f_1 * f_2$ is equal to $+\infty$ outside $]a + c, b + d[$ and, otherwise, $\forall t \in]a + c, b + d[$,

$$f_1 * f_2(t) = \begin{cases} f_1(a+) + f_2(c+) + \rho_1(t - a - c) & \text{if } t \leq b + c, \\ f_1(a+) + f_2(c+) + \rho_1(b - a) + \rho_2(t - b - c) & \text{if } t > b + c. \end{cases}$$

Geometrically, it means that the segments representing f_1 and f_2 are concatenated by increasing slopes (see Figure 6).

Proof. By definition, $f_1 * f_2(t) = \inf_{0 \leq s \leq t} f_1(s) + f_2(t - s)$. Then $f_1 * f_2(t)$ is different from $+\infty$ if and only if there exists s such that $f_1(s) \neq +\infty$ and $f_2(t - s) \neq +\infty$, which means $s \in]a, b[$ and $t - s \in]c, d[$. The support of $f_1 * f_2$ is thus $]a + c, b + d[$.

Let $t \in]a + c, b + d[$. Then,

$$\begin{aligned} f_1 * f_2(t) &= \inf_{0 \leq s \leq t} f_1(s) + f_2(t - s) \\ &= \inf_{\max(a, t-d) \leq s \leq \min(b, t-c)} [f_1(a+) + \rho_1(s - a) + f_2(c+) + \rho_2(t - s - c)] \end{aligned}$$

As $\rho_1 \leq \rho_2$, the infimum is reached for $s = \min(b, t - c)$ and

$$f_1 * f_2(t) = f_1(a+) + f_2(c+) - \rho_1 a + \rho_2(t - c) + (\rho_1 - \rho_2) \min(b, t - c).$$

As a consequence,

$$f_1 * f_2(t) = \begin{cases} f_1(a+) + f_2(c+) + \rho_1(t - a - c) & \text{if } t \leq b + c \\ f_1(a+) + f_2(c+) + \rho_1(b - a) + \rho_2(t - b - c) & \text{otherwise.} \end{cases}$$

■

Remark 4. *It can be easily checked that almost identical lemma can be stated for semi-closed, closed or mixed types of segments. It only affects both ends of the output which remains the same inside its support.*

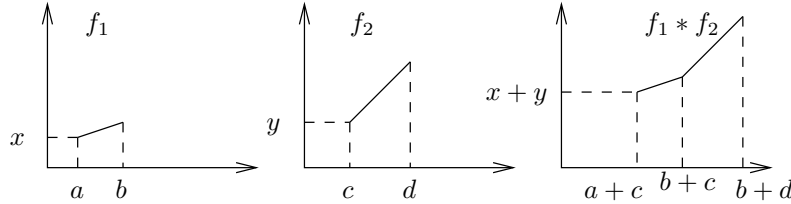

Figure 6: Convolution of two segments (case $\rho_1 \leq \rho_2$).

Proposition 7. *The classes $\mathcal{F}[\mathbb{R}_+, \mathbb{R}]$ and $\mathcal{F}[\mathbb{Q}_+, \mathbb{Q}]$ are stable under the convolution.*

Proof. A consequence of Lemma 4 is that the convolution of two segments of $\mathcal{F}[\mathbb{R}_+, \mathbb{R}]$ (resp. $\mathcal{F}[\mathbb{Q}_+, \mathbb{Q}]$) is piecewise affine in $\mathcal{F}[\mathbb{R}_+, \mathbb{R}]$ (resp. $\mathcal{F}[\mathbb{Q}_+, \mathbb{Q}]$). Let f, g be two functions in $\mathcal{F}[\mathbb{R}_+, \mathbb{R}]$ and let $(f_n)_{n \in \mathbb{N}}$ and $(g_n)_{n \in \mathbb{N}}$ be their respective elementary decompositions into segments and spots. Let $A \in \mathbb{R}_+$ and $n_0 = \min\{n \in \mathbb{N} \mid f_n \text{ and } g_n \text{ have a support disjoint from } [0, A]\}$. Since for all $t \in \mathbb{R}_+$, $f * g(t)$ depend only on the values of f and g on $[0, t]$, the restriction of $f * g$ on $[0, A]$ satisfies $f * g = \min_{i, j \in \{0, \dots, n_0\}} (f_i * g_j)|_{[0, A]}$. Thus $f * g$ is piecewise affine on $[0, A]$. It is true for every $A \in \mathbb{R}_+$, which means that $f * g$ is piecewise affine. The stability of the classes $\mathcal{F}[\mathbb{R}_+, \mathbb{R}]$ and $\mathcal{F}[\mathbb{Q}_+, \mathbb{Q}]$ is a consequence of their stability for the minimum. ■

3.2.2 Stability for the deconvolution

Let f be a segment or a spot and define \bar{f} as the function equal to f on its support and to $-\infty$ elsewhere. For a piecewise affine function with an elementary decomposition into segments and spots $f = \inf_{n \in \mathbb{N}} f_n$, one can associate the other decomposition $f = \sup_{n \in \mathbb{N}} \bar{f}_n$.

Lemma 5 (Deconvolution of spots). *Let f_1 and f_2 be two spots respectively on a and b . If $a \geq b$, then $\bar{f}_1 \otimes f_2$ is a spot on $a - b$ and $\bar{f}_1 \otimes f_2(a - b) = f_1(a) - f_2(b)$. If $a < b$, then $\bar{f}_1 \otimes f_2(t) = -\infty$, $\forall t \in \mathbb{R}_+$.*

Lemma 6 (Deconvolution of a segment and a spot). *Let f_1 be a segment on $]a, b[$ with slope ρ and f_2 be a spot on c . Then, $\bar{f}_1 \otimes f_2$ is a segment on $]a - c, b - c[\cap \mathbb{R}_+$ where $\bar{f}_1 \otimes f_2(t) = \rho(t + c - a) + f_1(a+) - f_2(c)$.*

Proof. By definition, $\bar{f}_1 \otimes f_2(t) = \sup_{s \geq 0} \bar{f}_1(t + s) - f_2(s)$. As f_2 is a spot on c , $\bar{f}_1 \otimes f_2(t) = \bar{f}_1(t + c) - f_2(c)$. Then, $\bar{f}_1 \otimes f_2(t)$ is finite if and only if $t + c \in]a, b[$ thus the support of $\bar{f}_1 \otimes f_2$ is $]a - c, b - c[\cap \mathbb{R}_+$. Let $t \in]a - c, b - c[\cap \mathbb{R}_+$, then $\bar{f}_1 \otimes f_2(t) = f_1(t + c) - f_2(c) = \rho(t + c - a) + f_1(a+) - f_2(c)$. ■

Lemma 7 (Deconvolution of a spot and a segment). *Let f_1 be a spot on a and f_2 be a segment on $]b, c[$ with slope ρ . Then, $\bar{f}_1 \otimes f_2$ is a segment on $]a - c, a - b[\cap \mathbb{R}_+$ where $\bar{f}_1 \otimes f_2(t) = f_1(a) - f_2(b+) + \rho(t + b - a)$.*

Proof. By definition, $\bar{f}_1 \otimes f_2(t) = \sup_{s \geq 0} \bar{f}_1(t + s) - f_2(s)$. As f_1 is a spot on a , $\bar{f}_1 \otimes f_2(t) = f_1(a) - f_2(a - t)$. Then $\bar{f}_1 \otimes f_2(t)$ is finite if and only if $a - t \in]b, c[$ and the support is $]a - c, a - b[\cap \mathbb{R}_+$. Let $t \in]a - c, a - b[\cap \mathbb{R}_+$. Then, $\bar{f}_1 \otimes f_2(t) = f_1(a) - f_2(a - t) = f_1(a) - \rho(a - t - b) - f_2(b+) = f_1(a) - f_2(b+) + \rho(t + b - a)$. ■

Lemma 8 (Deconvolution of segments). *Let f_1 and f_2 be two segments respectively defined on $]a, b[$ and $]c, d[$ with respective slopes ρ_1 and ρ_2 . Then, $\bar{f}_1 \otimes f_2$ has support $]a - d, b - c[\cap \mathbb{R}_+$ and, if $\rho_1 \geq \rho_2$,*

$$\bar{f}_1 \otimes f_2(t) = \begin{cases} f_1(t + d) - f_2(d-) & \text{if } a - d < t \leq b - d \\ f_1(b-) - f_2(b - t) & \text{if } b - d \leq t < b - c \\ -\infty & \text{otherwise.} \end{cases}$$

and if $\rho_1 \leq \rho_2$,

$$\bar{f}_1 \otimes f_2(t) = \begin{cases} f_1(a+) - f_2(a - t) & \text{if } a - d < t \leq a - c \\ f_1(t + c) - f_2(c+) & \text{if } a - c \leq t < b - c \\ -\infty & \text{otherwise.} \end{cases} .$$

Graphically, the deconvolution of two segments is the concatenation of them in decreasing slopes, starting from point $(a - d, f_1(a) - f_2(d))$ (see Figure 7).

Proof. We denote $\sigma_1 = f_1(a+)$ and $\sigma_2 = f_2(c+)$. We have $\bar{f}_1 \circ f_2(t) = \sup_{s \geq 0} (\bar{f}_1(t+s) - f_2(s))$. So, $\bar{f}_1 \circ f_2(t) \neq -\infty$ if and only if $\exists s \in]c, d[$ such that $t+s \in]a, b[$, i.e. $t \in]a-d, b-c[\cap \mathbb{R}_+$. Let $t \in]a-d, b-c[\cap \mathbb{R}_+$, then,

$$\begin{aligned} \bar{f}_1 \circ f_2(t) &= \sup_{s \in \mathbb{R}_+} (\bar{f}_1(t+s) - f_2(s)) \\ &= \sup(\rho_1(t+s-a) + \sigma_1 - \rho_2(s-c) - \sigma_2 \mid s \in]\max(c, a-t), \min(d, b-t)]) \\ &= \sigma_1 - \sigma_2 + \rho_1(t-a) + \rho_2c + \sup((\rho_1 - \rho_2)s \mid s \in]\max(c, a-t), \min(d, b-t))). \end{aligned}$$

If $\rho_1 \geq \rho_2$, then

$$\bar{f}_1 \circ f_2(t) = \sigma_1 - \sigma_2 + \rho_1(t-a) + \rho_2c + (\rho_1 - \rho_2) \min(d, b-t).$$

If $t \leq b-d$, $\bar{f}_1 \circ f_2(t) = \sigma_1 - \sigma_2 + \rho_1(t-a) + \rho_2c + (\rho_1 - \rho_2)d = f_1(t+d) - f_2(d-)$.

If $t \geq b-d$, $\bar{f}_1 \circ f_2(t) = \sigma_1 - \sigma_2 + \rho_1(t-a) + \rho_2c + (\rho_1 - \rho_2)(b-t) = f_1(b-) - f_2(b-t)$.

If $\rho_1 \leq \rho_2$, then

$$\bar{f}_1 \circ f_2(t) = \sigma_1 - \sigma_2 + \rho_1(t-a) + \rho_2c + (\rho_1 - \rho_2) \max(c, a-t).$$

If $t \leq a-c$, $\bar{f}_1 \circ f_2(t) = \sigma_1 - \sigma_2 + \rho_1(t-a) + \rho_2c + (\rho_1 - \rho_2)(a-t) = f_1(a+) - f_2(a-t)$.

If $t \geq a-c$, $\bar{f}_1 \circ f_2(t) = \sigma_1 - \sigma_2 + \rho_1(t-a) + \rho_2c + (\rho_1 - \rho_2)c = f_1(t+c) - f_2(c+)$. ■

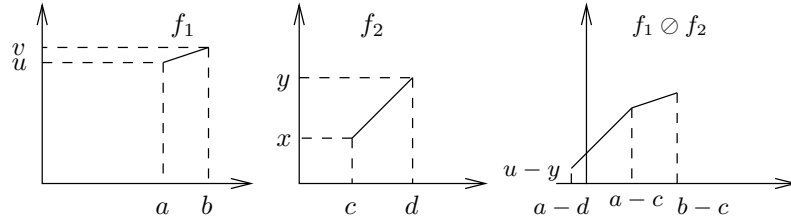

Figure 7: Deconvolution of two segments (case $\rho_1 \leq \rho_2$).

Proposition 8. *The class of the ultimately pseudo-periodic functions in $\mathcal{F}[\mathbb{Q}_+, \mathbb{Q}]$ is stable under the deconvolution.*

Proof. Let $f, g \in \mathcal{F}[\mathbb{Q}_+, \mathbb{Q}]$ be two ultimately pseudo-periodic functions such that $\forall t \geq T_f$ (resp. T_g), $f(t+d_f) = f(t) + c_f$ (resp. $g(t+d_g) = g(t) + c_g$). The reasoning follows the study of

the deconvolution in Proposition 4. It has already been proved there that $f \circledast g$ is ultimately pseudo-periodic from T_f , with period d_f (even if f and g are not plain or ultimately plain). It remains to show that $f \circledast g$ is piecewise affine on $[0, T_f + d_f[$. First remark that if $c_g/d_g < c_f/d_f$, then $\forall t \in \mathbb{R}_+$, $f \circledast g(t) = +\infty$. Otherwise if $c_f/d_f \leq c_g/d_g$, then $\forall t \in [0, T_f + d_f[$, $\sup_{s \geq 0} (f(t+s) - g(s))$ is reached over $0 \leq s \leq \max(T_f, T_g) + \text{lcm}(d_f, d_g) = T$. So, to compute $f \circledast g|_{[0, T_f + d_f[}$, f and g can be replaced by two ultimately affine functions \tilde{f} and \tilde{g} having the same values up to respectively $T + T_f + d_f$ and T , from which they are respectively equal to $-\infty$ and $+\infty$. These functions have finite decompositions into spots and segments $\tilde{f} = \sup_{0 \leq n \leq n_0} \bar{f}_n$ and $\tilde{g} = \inf_{0 \leq m \leq m_0} g_m$. Over $[0, T_f + d_f[$, $f \circledast g = \tilde{f} \circledast \tilde{g} = \sup_{n,m} \bar{f}_n \circledast g_m$. By using the four elementary lemma combining spots and segments (Lemma 5, 7, 6, 8), $\tilde{f} \circledast \tilde{g}$ is clearly piecewise affine. By pseudo-periodicity, $f \circledast g$ is thus piecewise affine over \mathbb{R}_+ . \blacksquare

Remark 5. *The ultimate periodicity is necessary for the stability of the deconvolution. This fact is detailed in [Bouillard and Thierry, 2007b]*

Corollary 1. *The classes of ultimately affine functions in $\mathcal{F}[\mathbb{R}_+, \mathbb{R}]$ and $\mathcal{F}[\mathbb{Q}_+, \mathbb{Q}]$ are stable under the deconvolution.*

Proof. This is a direct consequence of Propositions 8 and 3. \blacksquare

3.2.3 Stability for the subadditive closure

We first consider the subadditive closure of spots and iterated spots before focusing on segments and iterated segments, and we end by stating the stability results.

In some cases, we will use the following version of the Frobenius lemma:

Lemma 9 ([Ramirez-Alfonsin, 2005, Sylvester, 1884]). *Let $a_1, \dots, a_n \in \mathbb{Q}_+$, there exists $T \in \mathbb{Q}_+$ such that $(\mathbb{N}a_1 + \dots + \mathbb{N}a_n) \cap [T, +\infty[= T + \text{gcd}(a_1, \dots, a_n)\mathbb{N}$. The infimum of such values T also satisfies this relation, it is denoted $\text{Frob}(a_1, \dots, a_n)$. When $n = 2$, $\text{Frob}(a_1, a_2) = \text{lcm}(a_1, a_2) - a_1 - a_2 + \text{gcd}(a_1, a_2)$.*

Lemma 10. *The subadditive closure of a spot f on 0 is a spot on 0 with $f^*(0) = 0$ if $f(0) \geq 0$ and $f^*(0) = -\infty$ otherwise. The subadditive closure of a spot f on $a \neq 0$ is the function such that $f^*(ia) = if(a)$, $\forall i \in \mathbb{N}$ and $f^*(t) = +\infty$ elsewhere.*

Lemma 11. *Let $f \in \mathcal{F}$ be an iterated spot from T with period d and increment c . Then for all $k \in \mathbb{N}^*$, $f^{(k)}$ is an iterated spot from kT with period d and increment c .*

The subadditive closure of $f \in \mathcal{F}[\mathbb{Q}_+, \mathbb{Q}]$ is ultimately pseudo-periodic and can be explicitly computed.

Proof. The first part of the lemma follows from the definition of the convolution: for $k \in \mathbb{N}^*$, $\forall t \in \mathbb{R}_+$, $f^{(k)}(t) = \inf\{f(t_1) + \dots + f(t_k) \mid t_1, \dots, t_k \in \mathbb{R}_+, t_1 + \dots + t_k = t\}$. We have $f(t_1) + \dots + f(t_k) \neq +\infty$ if and only if $\forall 1 \leq j \leq k, \exists i_j \in \mathbb{N}, t_j = T + i_j d$, which implies that $t \in \{kT + id, i \in \mathbb{N}\}$. Then, $f(t_1) + \dots + f(t_k) = kf(T) + (t - kT)c/d$, which does not depend on the decomposition.

We now show how to compute explicitly the subadditive closure. We dismiss the case when $T = 0$ and $f(T) < 0$ treated in Lemma 1. Let us consider three cases:

- $\frac{f(T)}{T} > \frac{c}{d}$: we show that there exists $\beta \in \mathbb{N}^*$ such that for all $k \geq 0$, $f^{(k+\beta)} > f^{(k+1)}$. Since $T, d \in \mathbb{Q}_+$, there exist $\alpha, \beta \in \mathbb{N}$ such that $T + \alpha d = \beta T$, i.e. $\frac{\alpha}{\beta-1} = \frac{T}{d}$. To get the smallest β , choose $\beta - 1$ as the smallest denominator of the fraction $\frac{T}{d}$, which can be also written $\beta - 1 = \frac{d}{\gcd(T, d)}$. Then we have $f(T + \alpha d) = f(T) + \alpha c \neq +\infty$ and $f^{(\beta)}(\beta T) = \beta f(T) = f(T) + \alpha d f(T)/T \neq +\infty$. As $f(T)/T > c/d$, $f(T + \alpha d) < f^{(\beta)}(\beta T)$ and more generally $f^{(k+1)}(T + \alpha d) < f^{(k+\beta)}(\beta T)$ for all $k \geq 0$. Consequently $f^* = \min_{k \in \{0, \dots, \beta-1\}} f^{(k)}$, which is ultimately pseudo-periodic from $(\beta - 1)T$ with period d and increment c (like the β functions of this minimum).

- $\frac{f(T)}{T} < \frac{c}{d}$: as in the previous case, take $\alpha, \beta \in \mathbb{N}$ such that $T + \alpha d = \beta T$. The smallest α satisfying this relation is $\frac{T}{\gcd(T, d)}$. For $k \in \mathbb{N}^*$ and $i \in \mathbb{N}$, denote by $f_{k,i}$ the spot valued $kf(T) + ic$ at $kT + id$. Then $f^{(k)} = \inf_{i \geq 0} f_{k,i}$, and if we define $g_i = \inf_{k \geq 1} f_{k,i}$ for $i \geq 0$, we have $f^* = f^{(0)} \oplus \inf_{i \geq 0} g_i$. The functions g_i are iterated spots with period T and increment $f(T)$ from rank $T + id$. Since $f(T)/T < c/d$, we have $f(T + \alpha d) = f(T) + \alpha c > f(T) + \alpha d f(T)/T = f^{(\beta)}(\beta T)$, in other words $f_{1,\alpha} > f_{\beta,0}$. More generally, it can be checked that $f_{k+1,\alpha+i} > f_{k+\beta,i}$ for all $k, i \geq 0$. Thus $g_{\alpha+i} > g_i$ and $f^* = f^{(0)} \oplus \min_{i \in \{0, \dots, \alpha-1\}} g_i$. Like all the functions in this infimum, f^* is ultimately pseudo-periodic with period T and increment $f(T)$ from $T + (\alpha - 1)d = \beta T - d$.

- $\frac{f(T)}{T} = \frac{c}{d}$: we know that the support of f^* is $\{kT + id, i \in \mathbb{N}, k \in \mathbb{N}^*\} = T + \mathbb{N}T + \mathbb{N}d$, and for any decomposition $t = t_1 + \dots + t_k$ with $t_i \in T + \mathbb{N}d$, we have $f(t_1) + \dots + f(t_k) = kf(T) + (t - kT)c/d = tc/d$ which is independent from the decomposition. Thus $f^*(t) = t \frac{c}{d}$ on its support, and due to Frobenius Lemma 9, f^* is ultimately pseudo-periodic with period $\gcd(T, d)$ and increment $\frac{c}{d}(\gcd(T, d))$ from rank $Frob(T, d)$. ■

Applying i times Lemma 4 on a segment gives the following lemma.

Lemma 12. *Let $i \in \mathbb{N}^*$ and $f \in \mathcal{F}$ be the segment on $]a, b[$ with parameters σ, ρ . Then $f^{(i)}$ is the segment on $]ia, ib[$ with parameters $i\sigma, \rho$.*

The next lemma gives an explicit formula for the subadditive closure of a segment.

Lemma 13. *Let $f \in \mathcal{F}$ be the segment on $]a, b[$ with parameters σ, ρ .*

If $a = 0$ and $f(a+) < 0$, then $f^ = -\infty$ over \mathbb{R}_+ .*

If $f(a+)/a \leq f(b-)/b$, then f^ is ultimately plain and pseudo-periodic with period a and increment $f(a+) = \sigma$, from rank $a(\lfloor a/(b-a) \rfloor + 1)$. More precisely, $f^*(0) = 0$ and on any interval $]ia, (i+1)a[$, $i \in \mathbb{N}$, $f^* = f^{(i)}$ i.e.*

$$\forall t \in]0, a[, f^*(ia + t) = \begin{cases} if(a+) + \rho t & \text{if } i > \lfloor a/(b-a) \rfloor, \\ if(a+) + \rho t & \text{if } i \leq \lfloor a/(b-a) \rfloor \text{ and } t < i(b-a), \\ +\infty & \text{if } i \leq \lfloor a/(b-a) \rfloor \text{ and } t \geq i(b-a). \end{cases}$$

If $f(a+)/a > f(b-)/b$, then f^ is ultimately plain and pseudo-periodic with period b and increment $f(b-) = \sigma + \rho(b-a)$, from rank $b(\lfloor a/(b-a) \rfloor + 1)$. More precisely, on any interval $[(i-1)b, ib[$, $i \in \mathbb{N}^*$, $f^* = f^{(i)}$ i.e.*

$$\forall t \in]0, b[, f^*(ib - t) = \begin{cases} if(b-) - \rho t & \text{if } i > \lfloor a/(b-a) \rfloor + 1, \\ if(b-) - \rho t & \text{if } i \leq \lfloor a/(b-a) \rfloor + 1 \text{ and } t < i(b-a), \\ +\infty & \text{if } i \leq \lfloor a/(b-a) \rfloor + 1 \text{ and } t \geq i(b-a). \end{cases}$$

Proof. From Lemma 12, while $1 \leq i \leq \lfloor a/(b-a) \rfloor$, the functions $f^{(i)}$ have disjoint supports, which are also disjoint from the union of the supports of $f^{(j)}$, $j > \lfloor \frac{a}{b-a} \rfloor$. Thus if $i \leq \lfloor a/(b-a) \rfloor$, $f^* = f^{(i)}$ on $]ia, (i+1)a[$ and on $[(i-1)b, ib[$.

Suppose that $f(a+)/a \leq f(b-)/b$, i.e. $\sigma/a \leq \rho$ and $i > \lfloor a/(b-a) \rfloor$. As $f^{(i+1)}((i+1)a) = (i+1)\sigma \leq i\sigma + \rho a = f^{(i)}((i+1)a)$, we have $\forall t \in]ia, (i+1)a[$, $f^*(t) = f^{(i)}(t)$ and thus $f^*(t) = f^{(i)}(t) = i\sigma + \rho(t - ia)$ on $]ia, (i+1)a[$.

Suppose now that $f(a+)/a > f(b-)/b$, i.e. $f(b-)/b > \rho$ and $i > \lfloor a/(b-a) \rfloor$. As $f^{(i)}(ib-) = if(b-) - \rho i(b-a) < (i+1)f(b) - \rho b = f^{(i+1)}(ib)$, we have $\forall t \in [(i-1)b, ib[$, $f^*(t) = f^{(i)}(t)$. \blacksquare

Lemma 14. *Let $f \in F$ be an iterated segment with parameters T, d, a, c, ρ i.e. whose support is $\cup_{i \in \mathbb{N}}]T + id, T + id + a[$ and such that $\forall i \in \mathbb{N}, \forall x \in]0, a[, f(T + id + x) = f(T+) + ic + \rho x$. Then f^* is ultimately finite (thus ultimately plain) and ultimately pseudo-periodic.*

Proof. We dismiss the case when $T = 0$ and $f(T+) < 0$ already treated in Lemma 1.

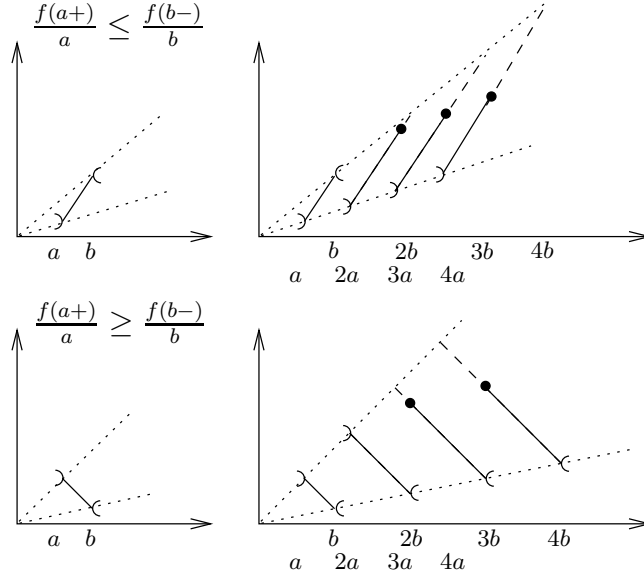

Figure 8: Subadditive closure of the two types of segments.

We first study the terms $f^{(k)}$, $k \in \mathbb{N}^*$. The function $f^{(k)}$ is finite on the intervals $]kT + id, kT + id + ka[$, $i \in \mathbb{N}$. If $ka \leq d$, all these intervals are disjoint, and for all $x \in]0, ka[$, we have $f^{(k)}(kT + id + x) = kf(T+) + ic + \rho x$. Indeed any decomposition of $kT + id + x$ into a sum of k values of the support of f has the form $(T + i_1d + x_1) + \dots + (T + i_kd + x_k)$ with $i_1 + \dots + i_k = i$ and $x_1 + \dots + x_k = x$, because $ka \leq d$. Then we have $f(T + i_1d + x_1) + \dots + f(T + i_kd + x_k) = kf(T+) + c(i_1 + \dots + i_k) + \rho(x_1 + \dots + x_k) = kf(T+) + ic + \rho x$ whatever the decomposition is.

If $ka > d$, then the intervals $]kT + id, kT + id + ka[$, $i \in \mathbb{N}$, overlap. For any $x > 0$, to get the value of $f(kT + x)$, we have to minimize $f(T + i_1d + x_1) + \dots + f(T + i_kd + x_k)$ where $T + i_1d + x_1, \dots, T + i_kd + x_k$ sum to $kT + x$. In other terms, we wish to minimize $kf(T+) + (\sum_{1 \leq j \leq k} i_j)c + (\sum_{1 \leq j \leq k} x_j)\rho$ under the constraints that $(\sum_{1 \leq j \leq k} i_j)d + (\sum_{1 \leq j \leq k} x_j) = x$ and $i_1, \dots, i_k \in \mathbb{N}$, $x_1, \dots, x_k \in]0, a[$, knowing that $d < ka$. By putting $I = \sum_{1 \leq j \leq k} i_j$ and $X = \sum_{1 \leq j \leq k} x_j$, it is equivalent to minimizing $Ic + X\rho$ where $Id + X = x$, $I \in \mathbb{N}$ and $X \in]0, ka[$. We clearly have to consider two cases depending on the comparison between ρ and c/d .

If $c/d \leq \rho$, we should maximize Id rather than X in the decomposition of x . It leads to $I = \lceil \frac{x}{d} \rceil - 1$ (due to the constraint $X > 0$) which also ensures that $0 < X \leq d < ka$. Then for all $x > 0$, $f^{(k)}(kT + x) = kf(T+) + Ic + \rho(x - Id) = kf(T+) + c(\lceil \frac{x}{d} \rceil - 1) + \rho(x - d(\lceil \frac{x}{d} \rceil - 1))$. In other terms, on any interval $]kT + id, kT + (i+1)d[$, $i \in \mathbb{N}$, we have $\forall x' \in]0, d[$, $f^{(k)}(kT + id + x') = kf(T+) + ic + \rho x'$. Thus the function $f^{(k)}$ is ultimately pseudo-periodic from kT , with period d and increment c .

If $\rho < c/d$, we should maximize X rather than Id , leading to $I = \lfloor \frac{x-ka}{d} \rfloor + 1$ if $x \geq ka$ (it satisfies $0 < X \leq d < ka$) and $I = 0$ if $x < ka$ (due to $I \in \mathbb{N}$), and all constraints are fulfilled. To write it in a convenient way, on any interval $[kT + (i-1)d + ka, kT + id + ka[$, $i \in \mathbb{N}^*$, we have $\forall x' \in]0, d]$, $f^{(k)}(kT + ka + id - x') = kf(T+a-) + ic - \rho x'$. The function $f^{(k)}$ is ultimately pseudo-periodic from $k(T+a)$, with period d and increment c . Note that for $x \in]0, ka[$, $f^{(k)}(kT + x) = kf(T+) + \rho x$.

Figure 9 illustrates the shapes of these iterated convolutions $f^{(k)}$ of the iterated segment f , depending on k and the comparison between c/d and ρ .

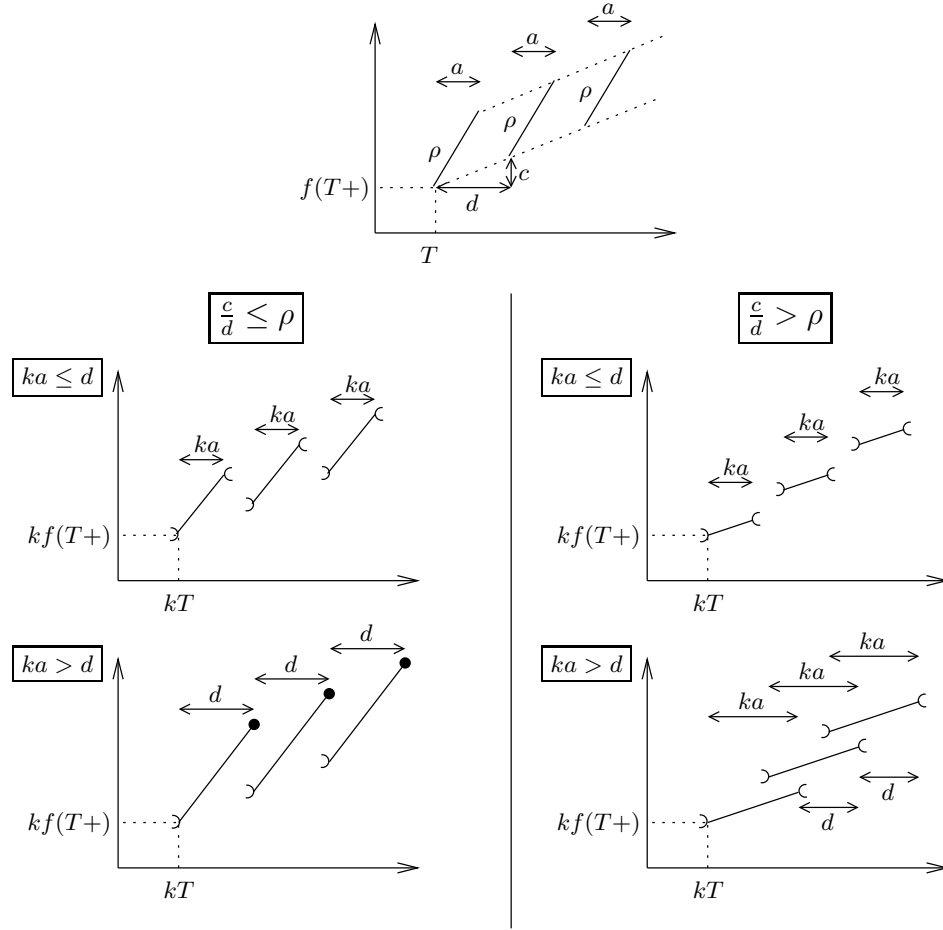

Figure 9: Iterated convolution $f^{(k)}$ of the iterated segment f .

We now study the subadditive closure, considering several cases.

From $k_0 = \min\{k \mid ka > d\} = \lfloor \frac{d}{a} \rfloor + 1$, all the functions $f^{(k)}$, $k \geq k_0$, are the same functions up to a translation.

- Suppose that $\frac{c}{d} \leq \rho$. For $k \geq k_0$ and $i \in \mathbb{N}$, let $f_{k,i}$ be the semi-closed segment of slope ρ

on the support $]kT + id, kT + (i + 1)d]$ such that $f_{k,i}(kT + id+) = kf(T+) + ic$, then we have $f^{(k)} = \inf_{i \geq 0} f_{k,i}$. For $i \in \mathbb{N}$, we define $g_i = \inf_{k \geq k_0} f_{k,i}$ which is clearly ultimately pseudo-periodic from $k_0T + id$ with period T and increment $f(T+)$ (but not necessary ultimately plain, it depends on whether $T \leq d$). The subadditive closure can be written $f^* = \inf_{0 \leq k < k_0} f^{(k)} \oplus \inf_{k \geq k_0} f^{(k)}$. The first term is ultimately pseudo-periodic from $(k_0 - 1)T$ with period d and increment c . The second term which is clearly ultimately plain from k_0T (as $f^{(k_0)}$ is). We now analyse the second term.

1. Suppose that $\frac{f(T+)}{T} \leq \frac{c}{d}$. Note that it implies $T > 0$. We first show that $\exists i_0 \geq 1, k_1 > k_0$ such that $\inf_{i \geq i_0} f_{k_0,i} \geq \inf_{i \geq 0} f_{k_1,i}$ over \mathbb{R}_+ . In other words, we wish to find some i_0 and k_1 such that the start of f_{k_0,i_0} is above $f_{k_1,0}$. More formally:

$$k_1T \leq k_0T + i_0d < k_1T + d \quad \text{and} \quad f_{k_0,i_0}(k_0T + i_0d+) \geq f_{k_1,0}(k_0T + i_0d+).$$

With $K = k_1 - k_0$, it is equivalent to:

$$i_0 - 1 < \frac{KT}{d} \leq i_0 \quad \text{and} \quad k_0f(T+) + i_0c \geq \rho((k_0T + i_0d) - k_1T) + k_1f(T).$$

That is:

$$i_0 = \lceil \frac{KT}{d} \rceil, \quad \text{and} \quad i_0 \left(\frac{c}{d} - \rho \right) \geq \frac{KT}{d} \left(\frac{f(T+)}{T} - \rho \right).$$

It leads to the inequation:

$$\lceil \frac{KT}{d} \rceil \left(\rho - \frac{c}{d} \right) \leq \frac{KT}{d} \left(\rho - \frac{f(T+)}{T} \right).$$

Such an integer $K \in \mathbb{N}^*$ exists since $0 \leq \rho - \frac{c}{d} < \rho - \frac{f(T+)}{T}$ (note that it is better to choose the smallest K satisfying the inequation in order to minimize i_0 and k_1 to have a shorter expression of f^* as we will see). Then due to the respective positions of the segments $f_{k,i}$, we have $\inf_{i \geq i_0} f_{k_0,i} \geq \inf_{i \geq 0} f_{k_1,i}$ over \mathbb{R}_+ and by translation, for all $\ell \geq 0$, $\inf_{i \geq i_0} f_{k_0+\ell,i} \geq \inf_{i \geq 0} f_{k_1+\ell,i} = f^{(k_1+\ell)}$ over \mathbb{R}_+ . Thus, $\inf_{k \geq k_0} f^{(k)} = \inf_{i \geq 0} g_i = \inf_{0 \leq i < i_0} g_i$, which is ultimately pseudo-periodic from $k_0T + (i_0 - 1)d$ with period T and increment $f(T+)$ (we already noted that it is also ultimately plain from this rank). Finally, since $\frac{c}{d} > \frac{f(T+)}{T}$, the function $f^* = \inf_{0 \leq k < k_0} f^{(k)} \oplus \inf_{0 \leq i < i_0} g_i$ is ultimately plain and pseudo-periodic with period T and increment $f(T+)$.

2. Suppose that $\frac{f(T+)}{T} > \frac{c}{d}$. We now show that there exists $k_1 > k_0$ such that $f^{(k_0)} \leq f^{(k_1)}$ over \mathbb{R}_+ , that will lead by translation to $f^{(k_0+\ell)} \leq f^{(k_1+\ell)}$ for all $\ell \geq 0$. We wish to find some i_0 and k_1 such that the start of $f^{(k_1)}$, i.e. the start of $f_{k_1,0}$, is above f_{k_0,i_0} . More formally,

$$k_0T + i_0d \leq k_1T < k_0T + (i_0 + 1)d \quad \text{and} \quad f_{k_0,i_0}(k_1T+) \leq f_{k_1,0}(k_1T+)$$

With $K = k_1 - k_0$, this is equivalent to

$$i_0 \leq \frac{KT}{d} < i_0 + 1 \quad \text{and} \quad k_0 f(T+) + i_0 c + \rho(k_1 T - (k_0 T + i_0 d)) \leq k_1 f(T+),$$

that is

$$i_0 = \lfloor \frac{KT}{d} \rfloor, \quad \text{and} \quad i_0 \left(\rho - \frac{c}{d} \right) \geq \frac{KT}{d} \left(\rho - \frac{f(T+)}{T} \right),$$

which leads to the inequation

$$\lfloor \frac{KT}{d} \rfloor \left(\rho - \frac{c}{d} \right) \geq \frac{KT}{d} \left(\rho - \frac{f(T+)}{T} \right).$$

Such an integer $K \in \mathbb{N}^*$ exists since $0 \leq \rho - \frac{f(T+)}{T} < \rho - \frac{c}{d}$. We can choose any solution K to the inequation (choose the smallest one to minimize the associated i_0 and k_1 and thus the next expression of the subadditive closure). Then we clearly have $f^{(k_1)} \geq f^{(k_0)}$ and by translation $f^{(k_1+\ell)} \geq f^{(k_0+\ell)}$ for all $\ell \geq 0$. Thus $f^* = \inf_{0 \leq k < k_0} f^{(k)} \oplus \inf_{k_0 \leq k < k_1} f^{(k)}$ which is ultimately plain and pseudo-periodic from $(k_1 - 1)T$ with period d and increment c .

• Suppose that $\frac{c}{d} > \rho$. For $k \geq 1$, let $f_{k,0}$ be the segment of slope ρ on the support $]kT, k(T+a)[$ such that $f_{k,0}(k(T+a)-) = kf(T+a-) = kf(T+) + \rho ka$, and for $i \geq 1$, let $f_{k,i}$ be the semi-closed segment of slope ρ on the support $[kT + ka + (i-1)d, kT + ka + id[$ such that $f_{k,i}(kT + ka + id-) = kf(T+a-) + ic$. We know that for all $k \geq k_0 = \min\{k \mid ka > d\}$, $f^{(k)} = \inf_{i \geq 0} f_{k,i}$ which is ultimately pseudo-periodic with period d and increment c . We also define for all $i \geq 0$, $g_i = \inf_{k \geq k_0} f_{k,i}$. All the semi-closed segments $f_{k,i}$, $k, i \geq 1$, are identical up to a translation, and for all $i \geq 1$, g_i is clearly ultimately pseudo-periodic with period $(T+a)$ and increment $f(T+a-)$. For $i = 0$, the asymptotic behavior of g_0 depends on the comparison between ρ and $\frac{f(T+a-)}{T+a}$. If $\rho > \frac{f(T+a-)}{T+a}$, then g_0 is ultimately pseudo-periodic from $k_0 T$ with period T and increment $f(T+)$, it is composed of semi-closed segments of slope ρ . Otherwise if $\rho \leq \frac{f(T+a-)}{T+a}$, then g_0 is ultimately pseudo-periodic from $k_0(T+a)$ with period $T+a$ and increment $f(T+a-)$, it is composed of semi-closed segments of slope ρ .

The subadditive close can be written $f^* = \inf_{0 \leq k < k_0} f^{(k)} \oplus \inf_{k \geq k_0} f^{(k)}$. The first term is ultimately pseudo-periodic from $(k_0 - 1)(T+a)$ with period d and increment c . We now study the second term.

1. Suppose that $\frac{f(T+a-)}{T+a} > \frac{c}{d}$. We show that $\exists k_1 > k_0$ such that the end of $f_{k_1,0}$ is above some $f_{k_0,i}$. More formally, there exists some $i_0 \geq 1$ and $k_1 > k_0$ such that

$$k_0(T+a) + (i_0 - 1)d < k_1(T+a) \leq k_0(T+a) + i_0 d \quad \text{and} \quad f^{(k_0)}(k_1(T+a)-) \leq f^{(k_1)}(k_1(T+a)-).$$

With $K = k_1 - k_0$, this is equivalent to

$$i_0 - 1 < \frac{K(T+a)}{d} \leq i_0 \quad \text{and} \quad k_0(f(T+) + \rho a) + i_0 c \leq k_1(f(T+) + \rho a) - \rho((k_0 - k_1)(T+a) + i_0 d),$$

that is

$$i_0 = \lceil \frac{K(T+a)}{d} \rceil \quad \text{and} \quad i_0 c + K\rho(T+a) - \rho i_0 d \leq Kf(T+) + K\rho a,$$

which leads to the inequation.

$$\lceil \frac{K(T+a)}{d} \rceil \left(\frac{c}{d} - \rho \right) \leq \frac{K(T+a)}{d} \left(\frac{f(T+a-)}{T+a} - \rho \right).$$

This is satisfied for some integer $K \in \mathbb{N}^*$ since $0 < \frac{c}{d} - \rho < \frac{f(T+a-)}{T+a} - \rho$. Then for k_1 and i_0 satisfying the constraints, due to the respective positions of the segments $f_{k,i}$, we have $\inf_{0 \leq i < i_0} f_{k_0,i} \leq f_{k_1,0}$ over \mathbb{R}_+ , and more generally, for all $\ell, m \geq 0$, we have $\inf_{m \leq i \leq i_0+m} f_{k_0+\ell,i} \leq f_{k_1+\ell,m}$. It implies that for all $\ell \geq 0$, $f^{(k_0+\ell)} \leq f^{(k_1+\ell)}$ over \mathbb{R}_+ and thus $\inf_{k_0 \leq k} f^{(k)} = \inf_{k_0 \leq k < k_1} f^{(k)}$ which is ultimately pseudo-periodic from $(k_1 - 1)(T+a)$ with period d and increment c (like the functions $f^{(k)}$, $k_0 \leq k < k_1$). Finally, f^* is ultimately pseudo-periodic from $(k_1 - 1)(T+a)$ with period d and increment c .

2. Suppose that $\frac{f(T+a-)}{T+a} < \frac{c}{d}$. We wish to find some $k > k_0$ and i_0 such that the end of f_{k_0,i_0} is above $f_{k_1,0}$. More formally

$$k_1(T+a) - d < k_0(T+a) + i_0 d \leq k_1(T+a) \quad \text{and} \quad f^{(k_0)}(k_0(T+a) + i_0 d -) \geq f^{(k_1)}(k_0(T+a) + i_0 d -).$$

With $K = k_1 - k_0$, it is equivalent to:

$$i_0 \leq \frac{K(T+a)}{d} < i_0 + 1 \quad \text{and} \quad k_0 f(T+a-) + i_0 c \geq k_1 f(T+a-) - \rho((k_1 - k_0)(T+a) - i_0 d).$$

That is,

$$i_0 = \lfloor \frac{K(T+a)}{d} \rfloor \quad \text{and} \quad i_0 d \left(\frac{c}{d} - \rho \right) \geq K(T+a) \left(\frac{f(T+a-)}{T+a} - \rho \right)$$

It leads to the inequation:

$$\lfloor \frac{K(T+a)}{d} \rfloor \left(\frac{c}{d} - \rho \right) \geq \frac{K(T+a)}{d} \left(\frac{f(T+a-)}{T+a} - \rho \right)$$

which is satisfied for some integer $K \in \mathbb{N}^*$ since $\frac{f(T+a-)}{T+a} - \rho < \frac{c}{d} - \rho$. Then for k_1 and i_0 satisfying the constraints, due to the respective positions of the segments $f_{k,i}$, we have $\inf_{i \geq i_0} f_{k_0,i} \geq \inf_{i \geq 0} f_{k_1,i} = f^{(k_1)}$ over the support of $f^{(k_1)}$. More generally, for all $\ell \geq 0$, we have $\inf_{i \geq i_0} f_{k_0+\ell,i} \geq \inf_{i \geq 0} f_{k_1+\ell,i} = f^{(k_1+\ell)}$ over the support of $f^{(k_1+\ell)}$. It leads to $\inf_{k \geq k_0} f^{(k)} = \inf_{0 \leq i < i_0} g_i$ and we have two cases.

If $\rho \leq \frac{f(T+a-)}{T+a}$, then $\inf_{0 \leq i < i_0} g_i$ is ultimately pseudo-periodic with period $T + a$ and increment $f(T + a-)$ (like all g_i , $0 \leq i < i_0$). In this case, f^* is ultimately pseudo-periodic with period $T + a$ and increment $f(T + a-)$ (since $\frac{f(T+a-)}{T+a} < \frac{c}{d}$).

If $\frac{f(T+a-)}{T+a} < \rho$, then $\inf_{0 \leq i < i_0} g_i$ is ultimately equal to g_0 which is ultimately plain and pseudo-periodic with period T and increment $f(T+)$ (since $\frac{f(T+)}{T} < \frac{f(T+a-)}{T+a} < \frac{c}{d}$).

■

Proposition 9. *The classes $\mathcal{F}[\mathbb{R}_+, \mathbb{R}]$ and $\mathcal{F}[\mathbb{Q}_+, \mathbb{Q}]$ are stable under the subadditive closure.*

Moreover, let $f \in \mathcal{F}[\mathbb{Q}_+, \mathbb{Q}]$ (resp. $\mathcal{F}[\mathbb{Q}_+, \mathbb{R}]$) be an ultimately pseudo-periodic function, then f^ is ultimately pseudo-periodic in $\mathcal{F}[\mathbb{Q}_+, \mathbb{Q}]$ (resp. $\mathcal{F}[\mathbb{R}_+, \mathbb{R}]$).*

Proof. Let $f \in \mathcal{F}[\mathbb{R}_+, \mathbb{R}]$ and let $(f_n)_{n \in \mathbb{N}}$ be its decomposition into segments and spots. Let $A \in \mathbb{R}_+$ and n_0 be the smallest integer n such that f_n has a support disjoint from $[0, A]$. Since for all $t \in \mathbb{R}_+$, $f^*(t)$ only depends on the values of f on $[0, t]$, we have $f_{[0, A]}^* = (\min_{0 \leq i < n_0} f_i|_{[0, A]})^* = (f_0^* * \dots * f_{n_0}^*)_{[0, A]}$ by the morphism property of the star from \min to $*$. Applying Lemma 10, Lemma 13 and Proposition 7 for the stability of the convolution, we get that f^* is piecewise affine on $[0, A]$, and consequently on \mathbb{R}_+ . Note that everything remains in $\mathcal{F}[\mathbb{Q}_+, \mathbb{Q}]$ if f belongs to this class.

Let $f \in \mathcal{F}[\mathbb{Q}_+, \mathbb{Q}]$ be an ultimately plain pseudo-periodic function, we decompose f into a finite number of elementary functions f_i , $1 \leq i \leq n$, which are spots, segments, iterated spots or iterated segments and such that $f = \min_i f_i$. Then the morphism property of the star from \min to $*$ gives $f^* = f_1^* * \dots * f_n^*$. Lemma 10, Lemma 11, Lemma 13 and Lemma 14 ensure that each f_i^* is ultimately pseudo-periodic. Then we must consider two cases. In the first case, at least one f_i is a segment or an iterated segment which means that f_i^* is ultimately pseudo-periodic and ultimately finite (thus ultimately plain). Together with Proposition 4 for $*$ and the last remark in its proof, composing f_i^* with the other functions f_j^* yields an ultimately pseudo-periodic function which is also ultimately finite (thus ultimately plain). In the second case, all the f_i 's are spots or iterated spots. One can not directly apply Proposition 4. However since $f \in \mathcal{F}[\mathbb{Q}_+, \mathbb{Q}]$, its discontinuities have a smallest common denominator d . Let $g \in \mathcal{D}$ such that $g(t) = f(\frac{t}{d})$, then we clearly have $f^*(t) = [g^*]_{\mathbb{R}}(dt)$. Due to Proposition 5 for the discrete model, g^* is ultimately pseudo-periodic, thus f^* is also ultimately pseudo-periodic.

If $f \in \mathcal{F}[\mathbb{Q}_+, \mathbb{R}]$ is ultimately plain pseudo-periodic, the same reasoning still applies to prove the ultimate pseudo-periodicity, and $f^* \in \mathcal{F}[\mathbb{R}_+, \mathbb{R}]$ since this class is stable, but there exists some $f \in \mathcal{F}[\mathbb{Q}_+, \mathbb{R}]$ such that $f^* \notin \mathcal{F}[\mathbb{Q}_+, \mathbb{R}]$ (see [Bouillard and Thierry, 2007b]).

■

Putting together the results of the section gives the second stability theorem:

Theorem 2. *The class of plain ultimately pseudo-periodic functions of $\mathcal{F}[\mathbb{Q}_+, \mathbb{Q}]$ is stable under the Network Calculus operations $+$, $-$, \min , \max , $*$, \otimes and the subadditive closure.*

Like Theorem 1, weakening the statement to ultimately plain pseudo-periodic functions in $\mathcal{F}[\mathbb{Q}_+, \mathbb{Q}]$ does not work (see Remark 3).

In fact, thanks to the Interpolation Proposition 1, Theorem 2 provides a new proof of Theorem 1 for \mathcal{D} .

Here are some other corollaries of Theorem 2:

Corollary 2. *The non-decreasing ultimately pseudo-periodic functions of $\mathcal{F}[\mathbb{Q}_+, \mathbb{Q}]$ are stable under the Network Calculus operations $+$, \min , \max , $*$, \otimes and the subadditive closure, except $-$.*

Proof. It is known that the Network calculus operations, except $-$, preserve the non-decrease of the functions (e.g. see [Le Boudec and Thiran, 2001]). ■

As mentioned before, some stability results were already known for some classes of fluid functions. Recorded in [Baccelli et al., 1992], they are mainly stated through a representation of functions by formal power series in two variables γ and δ , and for $(\max, +)$ versions of Network Calculus operations which directly imply the same for their $(\min, +)$ counterparts up to a few small adjustments (e.g. right-continuous becomes left-continuous, convex becomes concave). Theorem 6.32 which is extended by Remark 6.33, pages 290-291, can be translated into “*non-decreasing left-continuous ultimately pseudo-periodic staircase functions of $\mathcal{F}[\mathbb{N}, \mathbb{R}]$ are stable under the operations \min , $*$ and the subadditive closure*”. It yields the same result for such staircase functions in $\mathcal{F}[\mathbb{Q}_+, \mathbb{R}]$, up to reducing the discontinuities to \mathbb{N} by multiplying them by a common denominator (such denominators always exist in ultimately pseudo-periodic functions in $\mathcal{F}[\mathbb{Q}_+, \mathbb{R}]$). This result is generalized in Corollary 6.34, page 291, which yields the stability of a more general class of functions. Let us call a function f a *concave staircase* if it is piecewise affine and for any segment of f of support $]a, b[$, the continuation of this segment over $[0, b[$ is above f on $[0, b[$ (as a consequence those functions are non-decreasing). Non-decreasing staircase functions are clearly concave staircases. Corollary 6.34 in [Baccelli et al., 1992] can be translated into “*left-continuous ultimately pseudo-periodic concave staircase functions of $\mathcal{F}[\mathbb{Q}_+, \mathbb{R}]$ are stable under the operations \min , $*$ and the subadditive closure*”. The original $(\max, +)$ version is stated for functions in $\mathcal{F}[\mathbb{N}, \mathbb{R}]$ (but ultimate pseudo-periodicity enables to switch from \mathbb{N} to \mathbb{Q}_+ as above), with a finite set of slopes (which is even more precise).

Concerning usual modeling assumptions, in [Le Boudec and Thiran, 2001], it is shown that when dealing with arrival curves of left- or right-continuous cumulative flows, one can assume w.l.o.g. that they are left-continuous (Lemma 1.2.1, page 9).

Piecewise affine functions in $\mathcal{F}[\mathbb{R}_+, \mathbb{R}]$. Note that we have also proved that stability results apply for the *ultimately affine* functions of $\mathcal{F}[\mathbb{R}_+, \mathbb{R}]$ (for all operations except the subadditive closure) but they are lost for the ultimately pseudo-periodic functions: the combination of such pseudo-periodic functions is usually not pseudo-periodic. For instance it is well-know that the sum of two periodic functions with respective minimum periods d_1 and d_2 is aperiodic if d_1/d_2 is irrational [Corduneanu and Bohr, 1961], this directly implies the same for pseudo-periodic functions.

4 Algorithmic aspects

As a consequence of Theorems 1 and 2, we will mainly design algorithms implementing the Network Calculus operations for plain ultimately pseudo-periodic functions in $\mathcal{F}[\mathbb{Q}_+, \mathbb{Q}]$ and in \mathcal{D} . Thanks to the Interpolation Proposition 1, we can clearly deduce the output functions in \mathcal{D} by performing the operations in $\mathcal{F}[\mathbb{Q}_+, \mathbb{Q}]$ or $\mathcal{F}[\mathbb{Q}_+, \mathbb{R}]$.

4.1 Storage of ultimately pseudo-periodic functions

Let $f \in \mathcal{F}[\mathbb{Q}_+, \mathbb{Q}]$ be an ultimately pseudo-periodic function from T , with period d and increment c , such that $\forall t \geq T, f(t + d) = f(t) + c$. We choose to store the affine pieces of the function (in particular their slopes) on the interval $[0, T + d[$. One can store f as $([t_1, \dots, t_k], (T, d, c))$, where T is the rank from which f is pseudo-periodic, d is a period of f and c the corresponding increment, $[t_1, \dots, t_k]$ is the list of its affine pieces (spot+segment). More precisely, $\forall 1 \leq i \leq k, t_i = (x_i, f(x_i), y_i, \rho_i)$ such that f is affine on $]x_i, x_{i+1}[$ (resp. $]x_k, T + d[$ when $i = k$), $y_i = f(x_i +)$ and ρ_i is the slope on this interval. Whenever f is equal to $+\infty$ (resp. $-\infty$) on $]x_i, x_{i+1}[$, we arbitrarily set $y_i = +\infty$ (resp. $-\infty$) and $\rho_i = 0$.

We require that $x_1 = 0$, that there exists i_0 such that $x_{i_0} = T$, and that $x_k < T + d$. We can use a simple linked list for $[t_1, \dots, t_k]$, where t_k points back to t_{i_0} . Moreover, an integer counter η_f (initialized to 0) is associated with f , which tells as we move forward through the data structure how many times the link between t_k and t_{i_0} has been used. Finally, we add an extra pointer pos which points to one tuple t_i so that we can access it in constant time (it marks the tuple which is currently scanned).

Note that this choice of data structure has imposed the assumption $\forall t \geq T, f(t+d) = f(t) + c$ rather than $\forall t > T$. Of course, one can easily find another simple data structure which fits better the definition with the strict inequality.

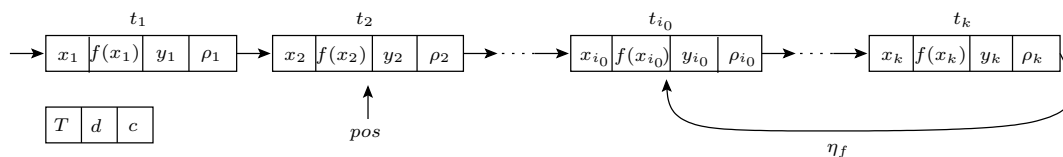

Figure 10: A simple data structure to store ultimately pseudo-periodic functions.

We have deliberately chosen a simple data structure sufficient to run our algorithms implementing Network Calculus operations. It is clear that this data structure can be adjusted to specific programming languages or can be enforced if there is a need to perform efficiently some other operations, e.g. given the function f , quickly compute $f(x)$ for any $x \in \mathbb{R}_+$.

To save space, one optimization could consist in aggregating spots and segments into (semi-)closed segments whenever feasible. The algorithms we present can be adjusted to deal with these mixed types of segments without changing their complexity, as mentioned in Remark 4 for the convolution and with a small amount of work for the other operations. This optimization has been considered for the current C++ implementation of our algorithms (COINC project, [COINC]).

In all the section, we use our data structure with spots and open segments to describe our algorithms and analyze their complexities. We need a routine **Extend** (f, T', d') , which is only defined for $T' \geq T$ and if d divides d' and returns an extended description of f where all tuples over $[0, T'[,$ and then over $[T', T' + d'[,$ are given in the linked list and where the loop pointer joins the last tuple to the tuple starting at T' . That function runs in linear time in the size of spots and segments of the extension. That function may also add the new spots/segments “on the fly” in constant time, for instance while merging sorted lists of discontinuities for the addition, the minimum of functions.

Our algorithms are designed for ultimately pseudo-periodic functions but directly apply to ultimately affine functions by choosing for them an arbitrary period as observed in Remark 1. For instance a T-SPEC (M, p, r, b) arrival curve α with $\alpha(0) = 0$ and $\forall t \in \mathbb{R}_+^*, \alpha(t) = \min(M+pt, rt+b)$ can be stored as $(([0, 0, M, p), (\frac{b-M}{p-r}, \frac{bp-Mr}{p-r}, \frac{bp-Mr}{p-r}, r)], (\frac{b-M}{p-r}, 1, r))$.

Concerning the main parameters and the storage space of an ultimately pseudo-periodic function f (resp. f_i) in $\mathcal{F}[\mathbb{Q}_+, \mathbb{Q}]$, we will denote by T_f (resp. T_i), d_f (resp. d_i), c_f (resp. c_i) a rank of pseudo-periodicity, a period and its associated increment. We will also denote by n_f (resp. n_i)

the number of tuples in the *transient* part of the function, i.e. over $[0, T[$, and by p_f (resp. p_i) the number of tuples in the *pseudo-periodic* part of the function, i.e. over $[T, T + d[$, and we will use the notation $N_f = n_f + p_f$ (resp. $N_i = n_i + p_i$) for the size of all tuples representing f (resp. f_i). Let \odot be a Network Calculus operation. Then, given an algorithm implementing it, notations like $N_{f \odot g}$ or $d_{f \odot g}$ will refer to the size or the parameter of the output for *this* algorithm.

Note that, as shown in Subsection 2.1, checking whether the output of any Network Calculus operation is well-defined can be easily done from inputs in linear time.

4.2 Addition of ultimately pseudo-periodic functions

Let f_1 and f_2 be two ultimately pseudo-periodic functions in $\mathcal{F}[\mathbb{Q}_+, \mathbb{Q}]$. From Proposition 4, we know that the addition of those two functions is ultimately pseudo-periodic from $\max(T_1, T_2)$ with a period $d = \text{lcm}(d_1, d_2)$ and an associated increment $c = \frac{c_1}{d_1}d + \frac{c_2}{d_2}d$. As a consequence, it is sufficient to compute the addition on the interval $[0, \max(T_1, T_2) + d[$. The discontinuities of $f_1 + f_2$ are included within the union of the discontinuities of f_1 and f_2 . Thus one way to compute $f_1 + f_2$ consists in merging the sorted lists of discontinuities of f_1 and f_2 , and compute the additions at each discontinuities and between consecutive pairs of discontinuities. It can be done through a single pass over f_1 and f_2 with the following complexity (N_i^e stands for the number of tuples when *extending* the function):

Proposition 10. *Let $f_1, f_2 \in \mathcal{F}[\mathbb{Q}_+, \mathbb{Q}]$ both ultimately pseudo-periodic. If $T_1 = T_2 = T$ and $d_1 = d_2 = d$, then $f_1 + f_2$ can be computed in time $\mathcal{O}(N_{f_1+f_2})$ where $N_{f_1+f_2} = N_1 + N_2$.*

Consequently, in the general case, $f_1 + f_2$ can be computed in time $\mathcal{O}(N_{f_1+f_2})$ where $N_{f_1+f_2} = N_1^e + N_2^e$ with $N_1^e = n_1 + p_1 \frac{(T+d)-T_1}{d_1}$, $N_2^e = n_2 + p_2 \frac{(T+d)-T_2}{d_2}$, $T = \max(T_1, T_2)$ and $d = \text{lcm}(d_1, d_2)$.

Subtractions of functions work exactly in the same way.

Addition of several ultimately pseudo-periodic functions. There are several solutions to compute the sum of k functions f_1, \dots, f_k . Whether the algorithm does a single pass over the data structures or not, the computation necessarily merge the sets of discontinuities of the functions f_i , $1 \leq i \leq k$. Several solutions work.

One is to modify Algorithm 1 so that it takes k functions in argument, and at each new discontinuity, it computes the sum of the values of f_i and the sum of the next segments. Finding the next discontinuity can be made in $\mathcal{O}(1)$ with the use of a binary heap which is initially set up in $\mathcal{O}(k)$ and updated in $\mathcal{O}(\log_2(k))$ when extracting or inserting a discontinuity. Updating

Algorithm 1: Addition of two functions (sketch).

Data: $f_1, f_2 \in \mathcal{F}[\mathbb{Q}_+, \mathbb{Q}]$ both ultimately pseudo-periodic.

Result: $f_1 + f_2$ with parameters T, d, c .

begin

$T \leftarrow \max T_1, T_2; d \leftarrow \text{lcm}(d_1, d_2); c \leftarrow (\frac{c_1}{d_1} + \frac{c_2}{d_2})d;$

Extend(f_1, T, d);

Extend(f_2, T, d);

Merge the sorted lists of discontinuities of f_1 and f_2 on $[0, T + d[$;

Compute $f_1 + f_2$ at each discontinuity and between each pair of consecutive discontinuities in the merged list;

end

the sum of all functions at a new discontinuity and between the next consecutive discontinuities requires $\mathcal{O}(1)$ amortized complexity (each discontinuity of each input function induces the change of only one term in the sum). Up to extending the functions, suppose that $\forall 1 \leq i \leq k, T_i = T$ and $d_i = d$, then the overall complexity is $\mathcal{O}(\log_2(k) \sum_{i=1}^k N_i)$.

Another solution is to add functions two by two (using Algorithm 1) by organizing the whole calculation as a balanced binary tree with the k inputs at the leaves and finally the output at the root (Divide& Conquer scheme). It gives a $\mathcal{O}(\log_2(k) N_{\sum f_i})$ algorithm where $N_{\sum f_i} \leq \sum_{i=1}^k N_i$, since each input discontinuity leads to at most $\lceil \log_2(k) \rceil$ constant time operations (comparisons or sums) along the branch from its leaf to the root. Another way to organize the pairwise sums of functions is to use the binary tree constructed with Huffman algorithm (where weights are the number of discontinuities, i.e. tuples in the data structure), it is proved that the overall complexity is better than the balanced binary tree.

4.3 Minimum of ultimately pseudo-periodic functions

Let f_1 and f_2 be two ultimately pseudo-periodic functions in $\mathcal{F}[\mathbb{Q}_+, \mathbb{Q}]$. Proposition 4 gives a sufficient condition so that their minimum is also ultimately pseudo-periodic: it works if they are both ultimately plain. If $\frac{c_1}{d_1} = \frac{c_2}{d_2}$, then the minimum has a period $d = \text{lcm}(d_1, d_2)$ and an associated increment $c = \frac{c_1}{d_1}d$. Otherwise if $\frac{c_1}{d_1} < \frac{c_2}{d_2}$, the minimum has a period $d = d_1$ and an associated increment $c = c_1$. There are at least two ways to compute the minimum:

1. One can precompute a rank T from which the minimum is pseudo-periodic, and then extend

the functions over $[0, T+d]$ and merge the two lists of discontinuities to compute the minimum at each discontinuity and between each pair of consecutive discontinuities (see Algorithm 2 when both inputs are ultimately plain).

2. Otherwise one can compute the minimum in a single pass, and find on the fly a rank from which the output is pseudo-periodic.

Algorithm 2: Minimum of two functions (sketch).

Data: $f_1, f_2 \in \mathcal{F}[\mathbb{Q}_+, \mathbb{Q}]$ both ultimately plain pseudo-periodic.

Result: $\min(f_1, f_2)$ with parameters T, d, c .

begin

```

case  $\frac{c_1}{d_1} < \frac{c_2}{d_2}$  :
  |  $d \leftarrow d_1; c \leftarrow c_1;$ 
  |  $M_1 \leftarrow \sup_{T_1 \leq t < T_1 + d_1} (f_1(t) - \frac{c_1}{d_1}t);$ 
  |  $m_2 \leftarrow \inf_{T_2 \leq t < T_2 + d_2} (f_2(t) - \frac{c_2}{d_2}t);$ 
  |  $T \leftarrow \max(\frac{M_1 - m_2}{\frac{c_2}{d_2} - \frac{c_1}{d_1}}, T_1, T_2);$ 

case  $\frac{c_1}{d_1} > \frac{c_2}{d_2}$  :
  |  $d \leftarrow d_2; c \leftarrow c_2;$ 
  | Compute  $T$  symmetrically as above;

case  $\frac{c_1}{d_1} = \frac{c_2}{d_2}$  :
  |  $d \leftarrow \text{lcm}(d_1, d_2); c \leftarrow \text{lcm}(d_1, d_2) \frac{c_1}{d_1};$ 
  |  $T \leftarrow \max(T_1, T_2);$ 
Extend( $f_1, T, d$ );
Extend( $f_2, T, d$ );
Merge the sorted lists of discontinuities of  $f_1$  and  $f_2$  on  $[0, T + d]$ ;
Compute  $\min(f, g)$  at each discontinuity and between each pair of consecutive
discontinuities in the merged list;

```

end

Proposition 11. *Let $f_1, f_2 \in \mathcal{F}[\mathbb{Q}_+, \mathbb{Q}]$ both ultimately plain pseudo-periodic. Then, with the notation of Algorithm 2, $\min(f_1, f_2)$ can be computed in time $\mathcal{O}(N_1^e + N_2^e)$ where $N_1^e = n_1 + p_1 \frac{(T+d)-T_1}{d_1}$, $N_2^e = n_2 + p_2 \frac{(T+d)-T_2}{d_2}$ and $N_{\min(f_1, f_2)} \leq 2(N_1^e + N_2^e)$.*

Proof. Computing M_1 (resp. m_2) can be done in $\mathcal{O}(p_1)$ (resp. $\mathcal{O}(p_2)$). Extending the data structure for f_1 and f_2 up to $T+d$ requires $\mathcal{O}(N_1^e + N_2^e)$ steps, and merging the two corresponding

lists of discontinuities can be done in $\mathcal{O}(N_1^e + N_2^e)$. Then between two discontinuities of the merged list, at most one new discontinuity may appear (at the intersect of two segments), which justifies the bound $N_{\min(f_1, f_2)} \leq 2(N_1^e + N_2^e)$. \blacksquare

The maximum of functions works exactly in the same way.

Minimum of several ultimately pseudo-periodic functions. Computing the minimum of several functions has actually been extensively studied in computational geometry where the problem is often referred as the computation of the lower envelope of functions. The next theorem sums up the main results which can be found in the literature. In the statement, a *total function* in \mathcal{F} is a function whose support is \mathbb{R}_+ and a *partial function* in \mathcal{F} is a function whose support is an interval of \mathbb{R}_+ . The parameter $\lambda_s(n)$ is the maximum length of an (n, s) Davenport-Schinzel sequence, it occurs in several problems from geometry, but its definition and its study belong to the theory of finite words [Agarwal and Sharir, 1995a, Agarwal and Sharir, 1995b]. The function $\alpha(n)$ is the inverse Ackermann function which grows extremely slowly, e.g. $\alpha(n) \leq 5$ when $n \leq 2^{65536}$ [Cormen et al., 2001].

Theorem 3 ([Agarwal and Sharir, 1995b, Attalah, 1985, Hershberger, 1989, Nielsen and Yvinec, 1998]).

The minimum (lower envelope) of a set of n continuous total functions, each pair of whose graphs intersect in at most s points, can be constructed, in an appropriate model of computation, in $\mathcal{O}(\lambda_s(n) \log n)$ time and the size of the output is $\mathcal{O}(\lambda_s(n))$. If the functions are partial, then their minimum can be computed in $\mathcal{O}(\lambda_{s+1}(n) \log n)$ time and the size of the output is $\mathcal{O}(\lambda_{s+2}(n))$. In the particular case when the functions are segments, the minimum can be computed in $\mathcal{O}(n \log N)$ time, where N is the size of the output which satisfies $N \leq \lambda_3(n) = \Theta(n\alpha(n))$.

The *appropriate model* assumes that each intersection between two functions can be computed in $\mathcal{O}(1)$ amortized time. It is actually the case when the functions are segments. The complexity for n total functions can be achieved thanks to a straight forward Divide & Conquer algorithm, which can be directly extended into a $\mathcal{O}(\lambda_{s+2} \log n)$ algorithm for partial functions [Agarwal and Sharir, 1995b, Boissonat and Yvinec, 1998]. The complexity for partial functions was improved in [Hershberger, 1989] by reorganizing the Divide & Conquer computation, yielding a $\mathcal{O}(\lambda_{s+1}(n) \log n)$ algorithm and thus a $\mathcal{O}(n \log n)$ algorithm for segments since $\lambda_2(n) = 2n - 1$. The output sensitive $\mathcal{O}(n \log N)$ algorithm in [Nielsen and Yvinec, 1998] uses those previous works but also introduces a preprocessing step called Marriage-before-Conquest. Some of these algorithm are implemented in libraries like CGAL [CGAL]. Concerning the upper bound

on the output size, note that it can be deduced from [Agarwal and Sharir, 1995b] that for all n , $\lambda_3(n) \leq 68(\alpha(n) + 1)n$, which has been refined into $\lambda_3(n) \leq 3n\alpha(n)$ for sufficiently large n in [Klazar, 1999].

As we will see in the next subsections, those results are useful for the computation of the convolution and the deconvolution.

4.4 Convolution of ultimately pseudo-periodic functions

Let f_1 and f_2 be two ultimately pseudo-periodic functions in $\mathcal{F}[\mathbb{Q}_+, \mathbb{Q}]$. The next algorithm for the convolution of f_1 and f_2 follows the proof of stability in Proposition 4:

1. The function f_1 is decomposed into $f_1 = f'_1 \oplus f''_1$ where $f'_1 = f_1$ on $[0, T_1[$ and $= +\infty$ elsewhere, is the transient part, and $f''_1 = f_1$ on $[T_1, +\infty[$ and $= +\infty$ elsewhere, is the pseudo-periodic part. The same decomposition is applied to $f_2 = f'_2 \oplus f''_2$.
2. We have $f_1 * f_2 = (f'_1 * f'_2) \oplus (f'_1 * f''_2) \oplus (f''_1 * f'_2) \oplus (f''_1 * f''_2)$, and some information about the pseudo-periodicity of each term.
3. The function $f'_1 * f'_2$ has a support included in $[0, T_1 + T_2[$, and is equal to $+\infty$ outside. To compute this term, let $(f'_{1,i})_{i \in I}$ (resp. $(f'_{2,j})_{j \in J}$) be the set of segments and spots of f'_1 (resp f'_2), i.e. $f'_1 = \min_{i \in I} f'_{1,i}$ (resp. $f'_2 = \min_{j \in J} f'_{2,j}$). Then $f'_1 * f'_2 = \min_{i \in I, j \in J} f'_{1,i} * f'_{2,j}$ where each $f'_{1,i} * f'_{2,j}$ is either a spot, a segment or two consecutive segments (see Lemma 2, 3 and 4). This minimum over $i \in I$ and $j \in J$ is the minimum of at most $2(|I| + |J|)$ segments and can be computed thanks to the algorithms from computational geometry presented in the previous subsection.
4. The term $f'_1 * f''_2$ is ultimately pseudo-periodic from $T_1 + T_2$ with period d_2 and increment c_2 , thus it is sufficient to compute it on $[0, T_1 + T_2 + d_2[$ (note that its support is within $[T_2, +\infty[$). This computation requires the values of f'_1 over $[0, T_1[$ and the values of f''_2 over $[T_2, T_1 + T_2 + d_2[$. Following the method for $f'_1 * f'_2$, decomposing into spots and segments the two functions on those intervals enables to compute the convolution on $[0, T_1 + T_2 + d_2[$.
5. The same method applies to $f''_1 * f'_2$ which is ultimately pseudo-periodic from $T_1 + T_2$ with period d_1 and increment c_1 .
6. The term $f''_1 * f''_2$ is ultimately pseudo-periodic from $T_1 + T_2 + d$ with period $d = \text{lcm}(d_1, d_2)$ and increment $d \min(\frac{c_1}{d_1}, \frac{c_2}{d_2})$, thus it is sufficient to compute it on $[0, T_1 + T_2 + 2d[$ (note that its

support is within $[T_1 + T_2, +\infty[)$. This computation requires the values of f_1'' over $[T_1, T_1 + 2d[$ and the values of f_2'' over $[T_2, T_2 + 2d[$. Decomposing into spots and segments the two functions on those intervals enables to compute the convolution on $[T_1 + T_2, T_1 + T_2 + 2d[$ and thus $[0, T_1 + T_2 + 2d[$.

7. The minimum of the four terms can be computed with a simple algorithm for the minimum like the ones presented in the previous subsection.

As explained in Proposition 4, it is sufficient that at least one of the two functions is ultimately plain to ensure that this scheme works.

Algorithm 3: Convolution of two functions (sketch).

Data: $f_1, f_2 \in \mathcal{F}[\mathbb{Q}_+, \mathbb{Q}]$ both ultimately pseudo-periodic.

Result: $f_1 * f_2$ with parameters T, d, c .

begin

Let $f_j = f_j' \oplus f_j''$, where $f_j' = f_j$ on $[0, T_j[$ and $+\infty$ elsewhere, and $f_j'' = f_j$ on $[T_j, +\infty[$ and $+\infty$ elsewhere, $j \in \{1, 2\}$;

$d \leftarrow \text{lcm}(d_1, d_2)$; $c \leftarrow d \min(\frac{c_1}{d_1}, \frac{c_2}{d_2})$;

Let $(f_{j,i}')_{i \in I_j'}$ be the set of spots and segments of f_j' over $[0, T_j[$;

Let $(f_{j,i}'')_{i \in I_j''}$ be the set of spots and segments of f_j'' over $[T_j, T_1 + T_2 + d_j[$;

Let $(f_{j,i}''')_{i \in I_j'''}$ be the set of spots and segments of f_j'' over $[T_j, T_j + 2d[$;

Use a lower envelope algorithm to compute

- $\min_{i \in I_1', j \in I_2'} f_{1,i}' * f_{2,j}' = f_1' * f_2'$ over \mathbb{R}_+ ;
- $\min_{i \in I_1', j \in I_2''} f_{1,i}' * f_{2,j}'' = f_1' * f_2''$ over $[0, T_1 + T_2 + d_2[$, knowing that $f_1' * f_2''$ has ult. pseudo-periodic parameters $T_1 + T_2, d_2, c_2$;
- $\min_{i \in I_1'', j \in I_2'} f_{1,i}'' * f_{2,j}' = f_1'' * f_2'$ over $[0, T_1 + T_2 + d_1[$, knowing that $f_1'' * f_2'$ has ult. pseudo-periodic parameters $T_1 + T_2, d_1, c_1$;
- $\min_{i \in I_1''', j \in I_2'''} f_{1,i}''' * f_{2,j}''' = f_1'' * f_2''$ over $[0, T_1 + T_2 + 2d[$, knowing that $f_1'' * f_2''$ has ult. pseudo-periodic parameters $T_1 + T_2 + d, d, c$;

return the minimum $(f_1' * f_2') \oplus (f_1' * f_2'') \oplus (f_1'' * f_2') \oplus (f_1'' * f_2'')$ with its parameters T, d, c .

end

Example 2. For the sake of clarity, we derive here an example of the computation of the convolution of two functions. Let f_1 be represented by $([(0, 0, 3, 1), (2, 5, 5, 0), (4, 5, 5, 1)], (2, 4, 2))$ and

f_2 be represented by $((0, 0, 0, 2), (2, 4, 4, 0), (5, 4, 4, 3)), (2, 4, 3)$). As a consequence, the period of $f_1 * f_2$ is $d = 4$ and the increment is $c = 2$. Functions f_1 and f_2 are depicted in Figure 11.

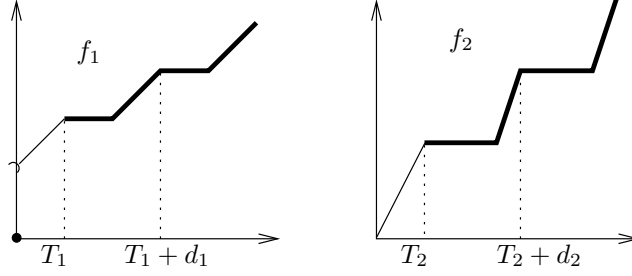

Figure 11: Two functions f_1 and f_2 to be convoluted.

The thinner part is the transient part f'_j and the bolder part is the periodic part, f''_j , $j \in \{1, 2\}$. The first step of the algorithm is to compute the convolution of the transient parts. This is done by computing the convolution of the segments/spots of the transient parts two by two, as depicted in Figure 12(a). The dashed lines are the convolution that are computed for the construction of the convolution. The second and third steps, shown in Figure 12(b) and (c) is the convolution of a transient part by a periodic part. Every segment/spot of the transient part of a function is convoluted with every segment/spot of the periodic part, and we know that the result is periodic from $T_1 + T_2$ with period $d (= d_1 = d_2)$. So we keep only the results in the interval $[0, T_1 + T_2 + d]$. The fourth step is to compute the convolution of the periodic parts. The result is periodic from $T_1 + T_2 + d$, so only the result restricted to $[T_1 + T_2, T_1 + T_2 + 2d]$ is computed. The result is depicted in Figure 12(d).

Finally, the minimum of those four functions is computed. One needs to extend the functions. The result is depicted in Figure 13.

Proposition 12. Let $f_1, f_2 \in \mathcal{F}[\mathbb{Q}_+, \mathbb{Q}]$ both ultimately pseudo-periodic such that $f_1 * f_2$ is ultimately pseudo-periodic, e.g. at least one is ultimately plain. Then using its notations, Algorithm 3 computes $f_1 * f_2$ in time $\mathcal{O}(N_1^e N_2^e \log \max(N_1^e, N_2^e) + N_1^e N_2^e \alpha(\max(N_1^e, N_2^e)))$ where $N_1^e = n_1 + p_1 \lceil \frac{(T+d)-T_1}{d_1} \rceil$, $N_2^e = n_2 + p_2 \lceil \frac{(T+d)-T_2}{d_2} \rceil$, $N_1^e = n_1 + p_1 \max(\lceil \frac{T_2+d_1}{d_1} \rceil, \frac{2d}{d_1})$ and $N_2^e = n_2 + p_2 \max(\lceil \frac{T_1+d_2}{d_2} \rceil, \frac{2d}{d_2})$. The size of the output satisfies $N_{f_1 * f_2} = \mathcal{O}(N_1^e N_2^e \alpha(\max(N_1^e, N_2^e)))$.

Proof. The sets $(f'_{1,i})_{i \in I'}$, $(f''_{1,i})_{i \in I''}$, $(f'''_{1,i})_{i \in I'''}$ of spots and segments have respective cardinals $= 2n_1, \leq 2(p_1 + p_1 \lceil \frac{T_2}{d_1} \rceil), = 2p_1 \frac{2d}{d_1}$, and can be generated in linear time with respect to their cardinals. The same holds for $(f'_{2,j})_{j \in J'}$, $(f''_{2,j})_{j \in J''}$, $(f'''_{2,j})_{j \in J'''}$. The next steps of Algorithm 3 can be analyzed through the quantities presented in Table 1.

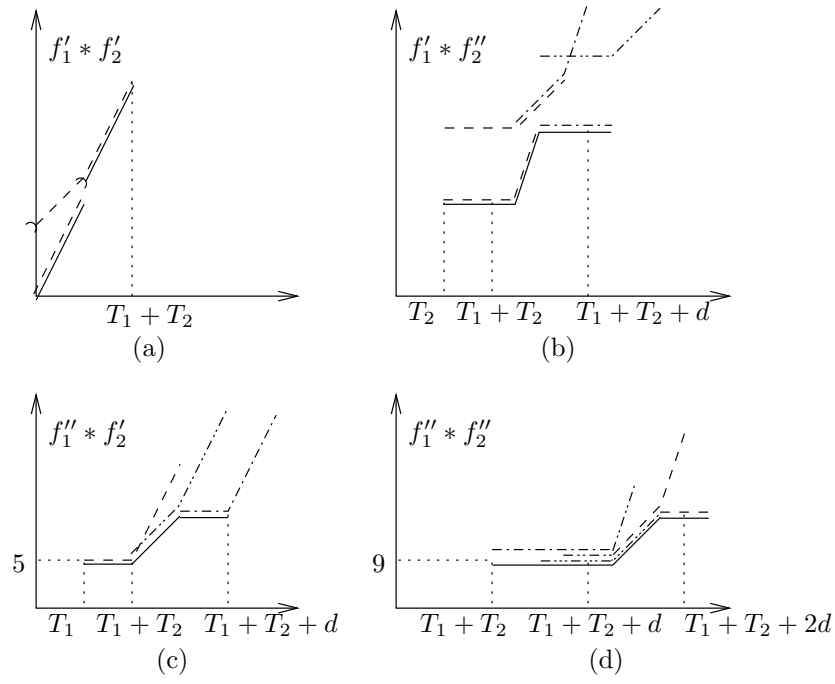

Figure 12: Steps of the convolution algorithm.

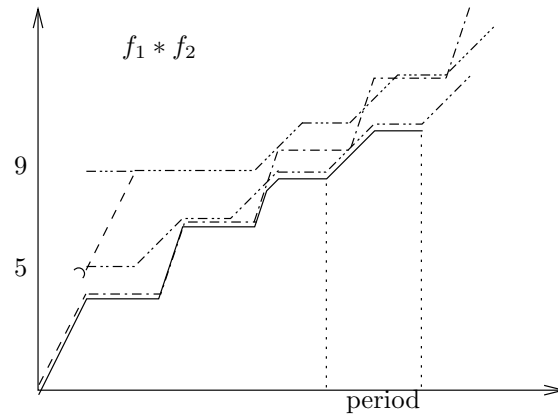

Figure 13: The convolution is the minimum of the convolutions computed in Figure 12.

Each elementary convolution in $(f'_{1,i} * f'_{2,j})_{i \in I', j \in J'}$, $(f'_{1,i} * f''_{2,j})_{i \in I', j \in J''}$, $(f''_{1,i} * f'_{2,j})_{i \in I'', j \in J'}$, $(f''_{1,i} * f''_{2,j})_{i \in I'', j \in J''}$ can be computed in $\mathcal{O}(1)$ time thanks to Lemma 2, 3 and 4. The minimum (lower envelope) of each of these four families can be computed with the algorithms mentioned in Theorem 3, thus in time $\mathcal{O}(M \log M)$ where M is the number of spots and segments generated by the respective elementary convolutions (knowing that an elementary convolution leads to at most two consecutive segments). During the last step of Algorithm 3, the minimum of these four minima can be computed by the simple one-pass algorithm. The pass extends the four functions over R_+ until a rank T of pseudo-periodicity is found, i.e. they are extended over the interval $[0, T + d[$. One needs to know the sizes of the four functions over this interval to give an upper bound on the complexity. One way to achieve that is to decompose once more the functions into spots and segments over $[0, T + d[$ this time and see each function as a minimum of the corresponding elementary convolutions, i.e. a minimum of spots and segments. It gives a bound on the size of the output thanks to the Davenport-Schinzel number λ_3 cited in Theorem 3. Note that if one can precompute quickly a small rank T of pseudo-periodicity, it can directly uses this scheme of decomposition over $[0, T + d[$, it enables to avoid the computation of the four intermediate convolutions, and then using the output sensitive algorithm becomes really relevant. In such a scheme, the performance relies on the success and speed when precomputing the small T .

Back to Algorithm 3, with the notation of Table 1, computing this last minimum requires $\mathcal{O}(N_{1'}^e N_{2'}^e \alpha(N_{1'}^e, N_{2'}^e) + N_{1'}^e N_{2''}^e \alpha(N_{1'}^e, N_{2''}^e) + N_{1''}^e N_{2'}^e \alpha(N_{1''}^e, N_{2'}^e) + N_{1''}^e N_{2''}^e \alpha(N_{1''}^e, N_{2''}^e))$ time and this is also an upper bound on the size of $f_1 * f_2$. To get the shorter form in the statement of the proposition using $N_1^e = N_{1'}^e + N_{1''}^e$ and $N_2^e = N_{2'}^e + N_{2''}^e$, use the fact that the function α is non-decreasing and subadditive.

In the same way, the first steps of computation of the four minima have a time complexity $\mathcal{O}(N_{1',2'} \log(N_{1',2'}) + N_{1',2''} \log(N_{1',2''}) + N_{1'',2'} \log(N_{1'',2'}) + N_{1'',2''} \log(N_{1'',2''}))$. Since \log is non-decreasing and subadditive, this complexity is upper bounded by $\mathcal{O}(N_1^\varepsilon N_2^\varepsilon \log \max(N_1^\varepsilon, N_2^\varepsilon))$ where $N_1^\varepsilon = n_1 + p_1 \max(\lceil \frac{T_2 + d_1}{d_1} \rceil, \frac{2d}{d_1})$ and $N_2^\varepsilon = n_2 + p_2 \max(\lceil \frac{T_1 + d_2}{d_2} \rceil, \frac{2d}{d_2})$. \blacksquare

Beyond this general algorithm, there exists some particular cases in which more efficient specialized algorithms are known. They concern convex functions and star shaped functions (which include the concave functions). A function $f \in \mathcal{F}$ is *star-shaped* if $t \mapsto f(t)/t$ is non-increasing over \mathbb{R}_+^* [Chang, 2000].

Proposition 13 ([Le Boudec and Thiran, 2001], Theorem 3.1.6). *Let $f, g \in \mathcal{F}[\mathbb{R}_+, \mathbb{R}]$.*

- *If f and g are convex, then $f * g$ is convex and obtained by putting end-to-end the different*

	$f'_1 * f'_2$	$f'_1 * f''_2$	$f''_1 * f'_2$	$f''_1 * f''_2$
Interval of computation (transitory & pseudo-periodic parts)	$[0, T_1 + T_2[$	$[T_2, T_1 + T_2 + d_2[$	$[T_1, T_1 + T_2 + d_1[$	$[T_1 + T_2, T_1 + T_2 + 2d[$
Interval to consider for f_1	$[0, T_1[$	$[0, T_1[$	$[T_1, T_1 + T_2 + d_1[$	$[T_1, T_1 + 2d[$
Tuples to consider in f_1	n_1	n_1	$p_1 \lceil \frac{T_2 + d_1}{d_1} \rceil$	$p_1 \frac{2d}{d_1}$
Interval to consider for f_2	$[0, T_2[$	$[T_2, T_1 + T_2 + d_2[$	$[0, T_2[$	$[T_2, T_2 + 2d[$
Tuples to consider in f_2	n_2	$p_2 \lceil \frac{T_1 + d_2}{d_2} \rceil$	n_2	$p_2 \frac{2d}{d_2}$
Number of elementary convolutions	$N_{1',2'} = n_1 n_2$	$N_{1',2''} = n_1 p_2 \lceil \frac{T_1 + d_2}{d_2} \rceil$	$N_{1'',2'} = n_2 p_1 \lceil \frac{T_2 + d_1}{d_1} \rceil$	$N_{1'',2''} = p_1 \frac{2d}{d_1} p_2 \frac{2d}{d_2}$
Complexity to compute their minimum	$N_{1',2'} \log(N_{1',2'})$	$N_{1',2''} \log(N_{1',2''})$	$N_{1'',2'} \log(N_{1'',2'})$	$N_{1'',2''} \log(N_{1'',2''})$
Tuples in f_1 acting in the definition over $[0, T + d[$	$N_{1'}^e = n_1$	$N_{1'}^e = n_1$	$N_{1''}^e = p_1 \lceil \frac{(T+d)-T_1}{d_1} \rceil$	$N_{1''}^e = p_1 \lceil \frac{(T+d)-T_1}{d_1} \rceil$
Tuples in f_2 acting in the definition over $[0, T + d[$	$N_{2'}^e = n_2$	$N_{2''}^e = p_2 \lceil \frac{(T+d)-T_2}{d_2} \rceil$	$N_{2'}^e = n_2$	$N_{2''}^e = p_2 \lceil \frac{(T+d)-T_2}{d_2} \rceil$
Complexity of the extension to $T + d$ during the computation of the final minimum = Θ (size of the extension)	$N_{1'}^e, N_{2'}^e, \alpha(N_{1'}^e, N_{2'}^e)$	$N_{1'}^e, N_{2''}^e, \alpha(N_{1'}^e, N_{2''}^e)$	$N_{1''}^e, N_{2'}^e, \alpha(N_{1''}^e, N_{2'}^e)$	$N_{1''}^e, N_{2''}^e, \alpha(N_{1''}^e, N_{2''}^e)$

Table 1: Analysis of the different steps of Algorithm 3

affine pieces of f and g sorted by increasing slopes, starting from $f(0) + g(0)$.

- If f and g are star-shaped, and $f(0) = g(0) = 0$, then $f * g$ is star-shaped and $f * g = \min(f, g)$.

This proposition is stated in [Le Boudec and Thiran, 2001] for non-decreasing and non-negative functions. However a careful look at the proof shows that it applies to general functions in \mathcal{F} .

Corollary 3. *Let $f, g \in \mathcal{F}[\mathbb{Q}_+, \mathbb{Q}]$, ultimately pseudo-periodic. If f, g are convex or f, g are star-shaped with $f(0) = g(0) = 0$, then $f * g$ can be computed in linear time.*

These results suggest another optimization of the encoding to speed-up the convolution algorithm by decomposing the functions into convex pieces [Bouillard, 2005].

4.5 Deconvolution of ultimately pseudo-periodic functions

To compute the deconvolution of two ultimately pseudo-periodic functions f_1, f_2 in $\mathcal{F}[\mathbb{Q}_+, \mathbb{Q}]$, we use the same scheme as for the convolution : we decompose f_1 and f_2 into spots and segments over appropriate intervals, then compute all the corresponding elementary deconvolutions and finally take their maximum with an upper envelope algorithm. From Proposition 8, $f_1 \circ f_2$ is ultimately pseudo-periodic from T_1 with period d_1 . Thus it is sufficient to compute $f_1 \circ f_2$ over $[0, T_1 + d_1[$. Moreover the proof shows that $\forall t \geq 0$, $\sup_{s \geq 0} (f(t + s) - g(s))$ is reached over $0 \leq s \leq \max(T_1, T_2) + \text{lcm}(d_1, d_2) = T$. To compute $f_1 \circ f_2$ over $[0, T_1 + d_1[$, we finally need the values of f_2 over $[0, T[$ and the values of f_1 over $[0, T + T_1 + d_1[$.

Proposition 14. *Let $f_1, f_2 \in \mathcal{F}[\mathbb{Q}_+, \mathbb{Q}]$ both ultimately pseudo-periodic. Then, with the notation of Algorithm 4, $f_1 \circ f_2$ can be computed in time $\mathcal{O}(N_1^e N_2^e \log \max(N_1^e, N_2^e))$ where $N_1^e = n_1 + p_1 \lceil \frac{T+d_1}{d_1} \rceil$ and $N_2^e = n_2 + p_2 \lceil \frac{T-T_2}{d_2} \rceil$. The output size satisfies $N_{f_1 \circ f_2} = \mathcal{O}(N_1^e N_2^e \alpha(\max(N_1^e, N_2^e)))$.*

Proof. The numbers N_1^e, N_2^e correspond to the numbers of tuples of f_1 and f_2 over respectively $[0, T + T_1 + d_1[$ and $[0, T[$. The computation of an elementary deconvolution between a spot or segment and a spot or segment can be done in $\mathcal{O}(1)$ time, thanks to Lemma 5, 7, 6 and 8. Each elementary deconvolution yields at most to consecutive segments. Their maximum can be computed with a upper envelope algorithm such as the ones for lower envelopes cited in Theorem 3. They have the same complexities and the size of the output admits the same kind of bound. ■

4.6 Subadditive closure of an ultimately pseudo-periodic function

Let $f \in \mathcal{F}[\mathbb{Q}_+, \mathbb{Q}]$ be an ultimately pseudo-periodic function, Algorithm 5 computes its subadditive closure by following the proof of Proposition 9.

Algorithm 4: Deconvolution of two functions (sketch).

Data: $f_1, f_2 \in \mathcal{F}[\mathbb{Q}_+, \mathbb{Q}]$ both ultimately pseudo-periodic.

Result: $f_1 \circledast f_2$ with parameters T_1, d_1, c_1 if $\frac{c_1}{d_1} \leq \frac{c_2}{d_2}$, $= +\infty$ otherwise.

begin

if $\frac{c_1}{d_1} > \frac{c_2}{d_2}$ **then**

 | $f_1 \circledast f_2 = +\infty$ over \mathbb{R}_+

else

 | $T \leftarrow \max(T_1, T_2) + \text{lcm}(d_1, d_2)$;

 | Let $(f_{1,i})_{i \in I}$ be the set of spots and segments of f_1 over $[0, T + T_1 + d_1[$;

 | Let $(f_{2,j})_{j \in J}$ be the set of spots and segments of f_2 over $[0, T[$;

 | Use an upper envelope algorithm to compute $\max_{i \in I, j \in J} f_{1,i} \circledast f_{2,j} = f_1 \circledast f_2$

 | over $[0, T_1 + d_1[$, knowing that $f_1 \circledast f_2$ has ult. pseudo-periodic parameters T_1, d_1, c_1 .

end

Algorithm 5: Subadditive closure (sketch).

Data: $f \in \mathcal{F}[\mathbb{Q}_+, \mathbb{Q}]$ ultimately pseudo-periodic.

Result: f^* .

begin

 | Let $(f_i)_{1 \leq i \leq k}$ be the finite set of spots, iterated spots, segments and iterated segments
 | such that $f = \min_{1 \leq i \leq k} f_i$;

 | Compute f_i^* for all $1 \leq i \leq k$ using the specific algorithms for spots, iterated spots,
 | segments and iterated segments;

 | Compute $f^* = f_1^* * \dots * f_k^*$ with a convolution algorithm.

end

Note that, due to the commutativity and associativity of $*$, several sequences of pairwise convolutions achieve the computation of $f_1^* * \dots * f_k^*$. In the proof of Proposition 9, in case f had at least one segment, the sequence of convolutions was carefully chosen so that Proposition 4 for $*$ ensured the ultimate pseudo-periodicity of each output without using any other result like Proposition 5 for the discrete model. Such a restriction (aimed at refining the proof) is not necessary for the computations. Any sequence of convolutions will give intermediate outputs which are ultimately pseudo-periodic: any convolution of some f_j^* , $j \in J \subseteq \{1, \dots, k\}$, is the subadditive closure of an ultimately pseudo-periodic function, namely $\min_{j \in J} f_j$, which is ultimately pseudo-periodic due to Proposition 9. Algorithm 3 can be used to compute the $k-1$ necessary convolutions.

Specific algorithms to compute the subadditive closure of spots, iterated spots, segments and iterated segments can be directly derived from the proofs of stability in Subsection 3.2.3, i.e. Lemma 10, 11, 13 and 14. They are described below. The four algorithms assume that the input function f satisfies $f(0) \geq 0$, otherwise $f^* = -\infty$ over \mathbb{R}_+ .

The complexity analysis of the whole Algorithm 5 involving a non constant number of convolutions remains open.

Remark 6. *All the algorithms that have been presented also apply to input functions in $\mathcal{F}[\mathbb{Q}_+, \mathbb{R}]$, and then the output may land in $\mathcal{F}[\mathbb{R}_+, \mathbb{R}]$. Note that even if we only use elementary operations on \mathbb{R} , allowing values in \mathbb{R} for the input functions may require to address some numerical issues due to the use of floats and thus further theoretical guarantees for a concrete implementation.*

5 Conclusion

The main stability results obtained in this article are summed up in Figure 14. The arrows between boxes indicate where the output function lands when applying the operations which label each arrow. If an arrow ends at a box different from the one where it started, it means that there exists some input functions whose output does not belong any longer to the initial class. The paper contains most of the examples illustrating this picture, the complementary ones are presented in [Bouillard and Thierry, 2007b].

We have also shown that we can make effective the stability results by describing algorithms which implement the Network Calculus operations for our stable plain ultimately pseudo-periodic classes.

Beyond the correction of the algorithms, we have tried to analyze their theoretical complexities

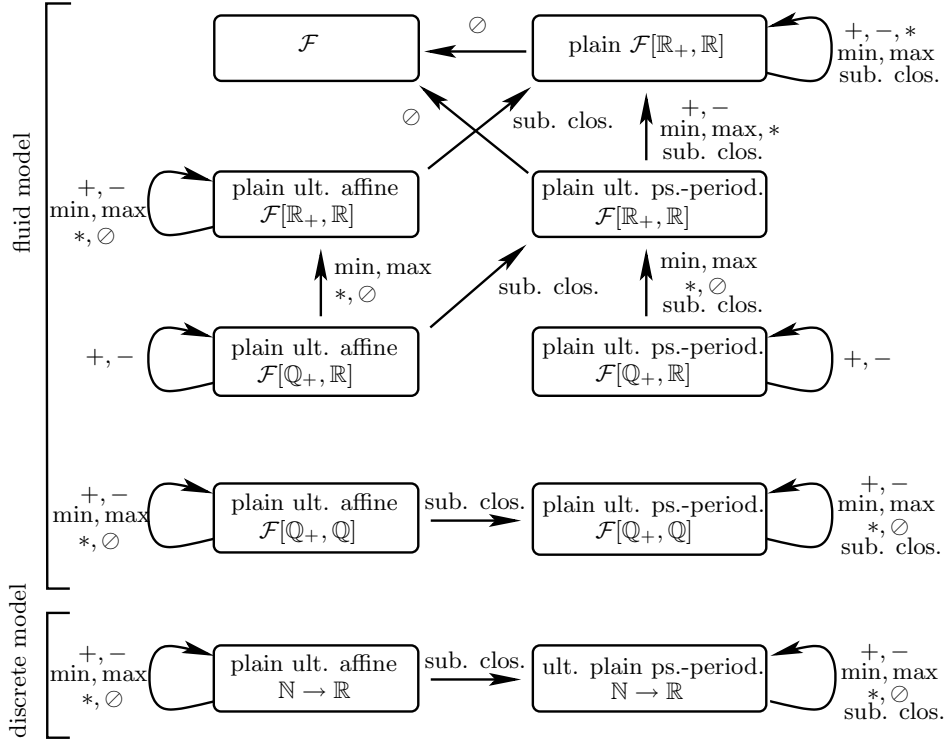

Figure 14: Stability/unstability of some classes of functions.

the best we could. Most of our complexity bounds take into account both the size of the inputs and the size of the output. It is natural since the whole output must be returned, but it raises two questions which require further work. What are the precise links and bounds between the size of the inputs and the size of the output, for each of the Network Calculus operations? This may enable to refine the complexity bounds for our algorithms. In particular, one can notice that we do not quantify the complexity of our algorithms for the subadditive closure, except that the size of the output may be exponential with the size of the inputs and that there exists an underlying NP-complete problem (which occurs for instance if one wants to compute the smallest rank of ultimate pseudo-periodicity, see [Bouillard and Thierry, 2007a]), which implies in both ways that our algorithms are exponential. Then we can wonder what are the ways to avoid outputs of size exponential with the size of their inputs? This is mainly an encoding question. For instance one could think of compressing the functions by taking into account the repeated patterns in the transitory part of the ultimately pseudo-periodic functions, as well as doing lazy computations, i.e. doing the full computation of a sequence of operations only when it is really necessary and otherwise maintain a formal expression of the output as an undeveloped combination of operations,

or finally by introducing new decompositions or transformations of the functions.

Acknowledgment

The authors wish to thank Bruno Gaujal for his precious advice. This work has been funded by the ARC COINC.

References

- [Agarwal and Sharir, 1995a] Agarwal, P. K. and Sharir, M. (1995a). *Davenport-Schinzel Sequences and Their Geometric Applications*. Cambridge University Press.
- [Agarwal and Sharir, 1995b] Agarwal, P. K. and Sharir, M. (1995b). Davenport-schinzel sequences and their geometric applications. Technical report, Department of Computer Science, Duke University.
- [Attalah, 1985] Attalah, M. J. (1985). Some dynamic computational geometry problems. *Comput. Math. Appl.*, 11:1171–1181.
- [Baccelli et al., 1992] Baccelli, F., Cohen, G., Olsder, G. J., and Quadrat, J.-P. (1992). *Synchronization and Linearity*. Wiley. Download from <http://www.maxplus.org>.
- [Boissonat and Yvinec, 1998] Boissonat, J. D. and Yvinec, M. (1998). *Algorithmic Geometry*. Cambridge University Press.
- [Bouillard, 2005] Bouillard, A. (2005). *Optimisation et analyse probabiliste de systèmes à événements discrets*. PhD thesis, École Normale Supérieure de Lyon.
- [Bouillard and Thierry, 2007a] Bouillard, A. and Thierry, E. (2007a). An algorithmic toolbox for network calculus. Technical report, IRISA.
- [Bouillard and Thierry, 2007b] Bouillard, A. and Thierry, E. (2007b). Some examples and counterexamples for $(\min, +)$ filtering operations. Technical report, IRISA.
- [CGAL] CGAL. Computational Geometry Algorithms Library (interfaced with Scilab through CGLAB).
- [Chang, 1999] Chang, C. S. (1999). Deterministic traffic specification via projections under the min-plus algebra. In *Proceedings of INFOCOM*, pages 43–50.

- [Chang, 2000] Chang, C. S. (2000). *Performance Guarantees in Communication Networks*. TNCS.
- [COINC] COINC. Computational issues in network calculus. <http://perso.bretagne.ens-cachan.fr/~bouillar/coinc>.
- [Corduneanu and Bohr, 1961] Corduneanu, C. and Bohr, H. (1961). *Almost Periodic Functions*. Wiley Interscience.
- [Cormen et al., 2001] Cormen, T. H., Leiserson, C. E., Rivest, R. L., and Stein, C. (2001). *Introduction to Algorithms*. MIT Press and McGraw-Hill.
- [Cottenceau et al] Cottenceau, B., Hardouin, L., and Lhommeau, M. Modèles et Systèmes Dynamiques, LISA, University of Angers, France.
- [Fidler and Recker, 2006] Fidler, M. and Recker, S. (2006). Conjugate Network Calculus: A Dual Approach Applying the Legendre Transform. *Elsevier Computer Networks Journal*, 50(8):1026–1039.
- [Gaubert] Gaubert, S. MaxPlus Project, INRIA, Rocquencourt, France.
- [Gaubert, 1992] Gaubert, S. (1992). *Théorie Linéaire des Systèmes dans les Dioïdes*. PhD thesis, École des mines de Paris. (in french).
- [Hershberger, 1989] Hershberger, J. (1989). Finding the upper envelope of n line segments in $\mathcal{O}(n \log n)$ time. *Inform. Process. Lett.*, 33:169–174.
- [Klazar, 1999] Klazar, M. (1999). On the maximum lengths of davenport-schinzel sequences. In *Contemporary Trends in Discrete Mathematics*, pages 169–178. AMS.
- [Le Boudec and Thiran, 2001] Le Boudec, J.-Y. and Thiran, P. (2001). *Network Calculus: A Theory of Deterministic Queuing Systems for the Internet*, volume LNCS 2050. Springer-Verlag.
- [Nielsen and Yvinec, 1998] Nielsen, F. and Yvinec, M. (1998). An output-sensitive convex hull algorithm for planar objects. *International Journal of Computational Geometry and Applications*, 8(1):39–66.
- [Oppenheim et al., 1997] Oppenheim, A. V., Willsky, A. S., and Nawab, S. H. (1997). *Signals and Systems*. Prentice-Hall.
- [Pandit, 2006] Pandit, K. (2006). *Quality of Service Performance Analysis based on Network Calculus*. PhD thesis, Technische Universität Darmstadt.

- [Pandit et al., 2004a] Pandit, K., Kirchner, C., Schmitt, J., and Steinmetz, R. (2004a). Optimization of the min-plus convolution computation under network calculus constraints. Technical report, Technische Universität Darmstadt.
- [Pandit et al., 2004b] Pandit, K., Schmitt, J., Kirchner, C., and Steinmetz, R. (2004b). Optimal allocation of service curves by exploiting properties of the min-plus convolution. Technical report, Technische Universität Darmstadt.
- [Pandit et al., 2006] Pandit, K., Schmitt, J., Kirchner, C., and Steinmetz, R. (2006). A transform for network calculus and its application to multimedia networking. In *SPIE Conference on Multimedia Computing and Networking (MMCN'06)*.
- [Ramirez-Alfonsin, 2005] Ramirez-Alfonsin, J. L. (2005). *The Diophantine Frobenius Problem*. Oxford University Press.
- [Rockfellar, 1996] Rockfellar, R. T. (1996). *Convex Analysis*. Princeton University Press.
- [Schmitt and Zdarsky, 2006] Schmitt, J. B. and Zdarsky, F. A. (2006). The disco network calculator: a toolbox for worst case analysis. In *Valuetools '06: Proceedings of the 1st international conference on Performance evaluation methodologies and tools*, page 8, New York, NY, USA. ACM Press.
- [Schmitt et al., 2006] Schmitt, J. B., Zdarsky, F. A., and Martinovic, I. (2006). Performance Bounds in Feed-Forward Networks under Blind Multiplexing. Technical Report 349/06, University of Kaiserslautern, Germany.
- [Sylvester, 1884] Sylvester, J. J. (1884). “question 7382”. *Mathematical Questions from the Educational Times*, 41:21.
- [Thiele] Thiele, L. Real-time calculus Research Project, Computer Engineering and Networks Laboratory, ETH Zurich, Switzerland.